

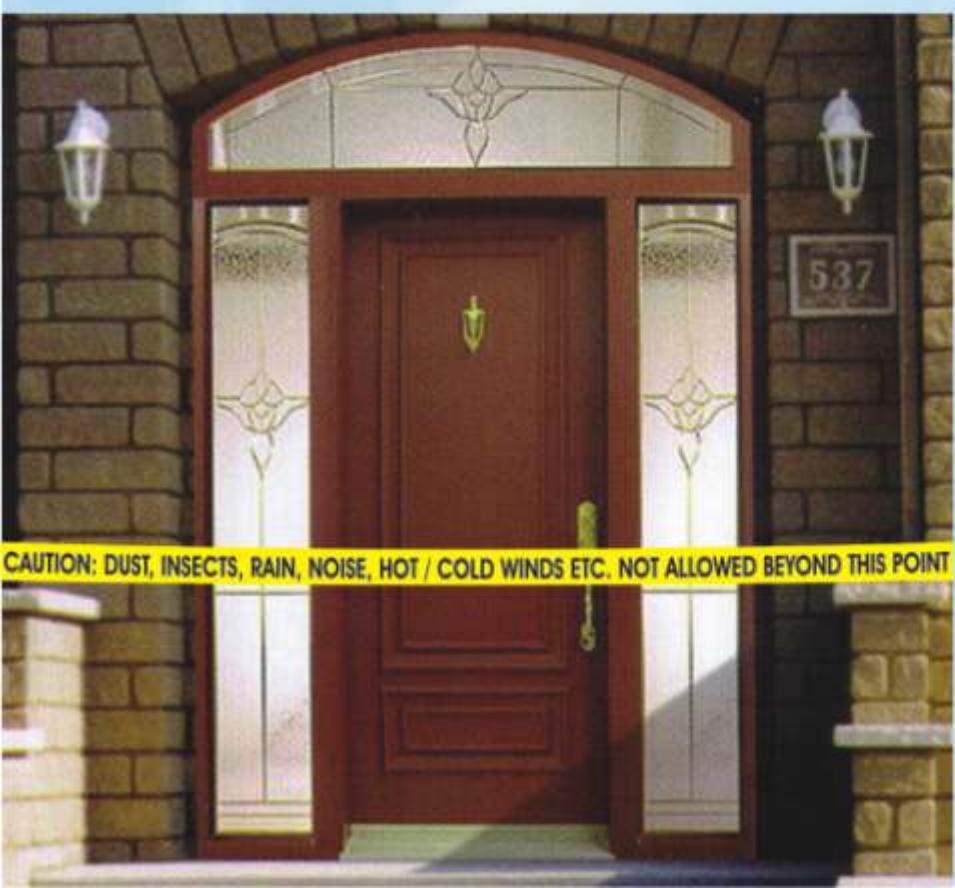

We at **Enviroseals** provides you the best Indian & imported seals for your doors and windows



CAUTION: DUST, INSECTS, RAIN, NOISE, HOT / COLD WINDS ETC. NOT ALLOWED BEYOND THIS POINT



Keep Out:

- Dust 
- Insects 
- Noise 
- Wind 
- Light 
- Rain 
- Smoke 
- Rodents 

# Various options available at Enviroseals

**E**nviroseals is an innovative, problem solving company started in 1989. Since Beginning our focus has always been on specialized sealing products for residential, commercial, industrial buildings and for the construction Industry. We engineered products with a combination of processes and materials in order to go beyond the limitations of any single component. We tried to transform the way Architects, Builders and Manufacturers consider the door / window sealing systems - Now every one has made these products an essential part of their buildings. These products were earlier considered last or even the least important for the buildings - but Enviroseals changed the way as now our products provide a comfortable and sophisticated lifestyle (Weather seals). These products are liked by all, because they are Simple in installation, Deliver outstanding Performance, are of Quality Finish and are Reasonably Priced.

At Enviroseals, we try to make each product a perfect fit - the best possible solution to each specific problem.

Our Customers feedback encourage us to make new profiles.

Since different states of India - have different Weather Conditions, People with Different Life Styles, Values and Beliefs, Temperature ( highs and lows ), etc it becomes more important for us to understand every aspect and design the profiles for their living and working premises.

**This Catalogue will give you a brief on the following seals :**

- Door frame or Perimeter Seals
- TwinOO & other Silicon Weather Stripping
- Standard and Elite Brush Strips
- Canceled Brush Strips
- Self Adhesive EPDM & Silicon Seals
- Threshold seals for Door Bottoms
- Scrapper Strips
- Clip - On Seals for Glass Doors
- Automatic Drop Seals
- Garage Door Seals
- Multi - Purpose seals
- Self Stick Polypile seals
- Finger Protection seals
- SideO & CenterO Seals
- Acoustic Perimeter and Drop Seals
- Astragal / Meeting Stile, Centro L Seals
- Variety of Threshold Plates
- Fire and Smoke Seals
- Seals for Sliding Doors & Windows, etc.

We have more than 2,00,000 Profiles to handle different known problems that arise with Doors and Windows.



# Why Enviroseals

Enviroseals  
NEW DELHI



**Doors & Windows must have gaps between** their leaves and the frame and between the bottom of the door and the floor. These gaps allow them to be opened and closed easily and accommodate normal movement.

However, they also allow the leakage of :-

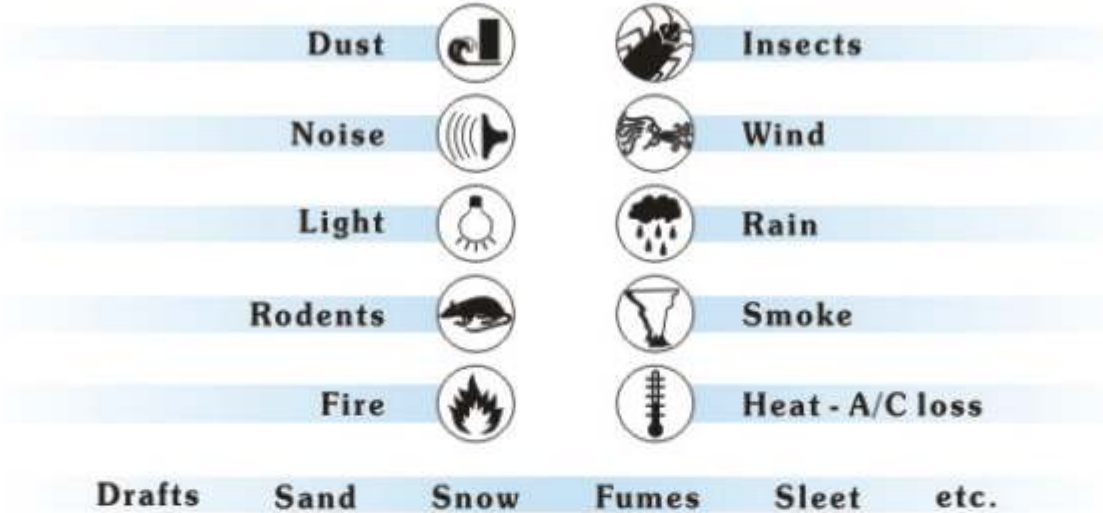

In these following pages, you will come across :-

**PERIMETER SEALS :** The Seals, that are designed for the gaps between the door & the frame or for the gaps between two doors.

**THRESHOLD SEALS :** The Seals, that are designed for the gap between the bottom of the door & the floor

## Install Enviroseals

Because, When a door is closed ....

- Enviroseal's, seal the **gaps between the door & the frame.**
- Seals the **gap between the bottom of the door and the floor,**

**Once you select and fit these seals properly, they provide a complete & continuous sealing to all types of doors & windows.**

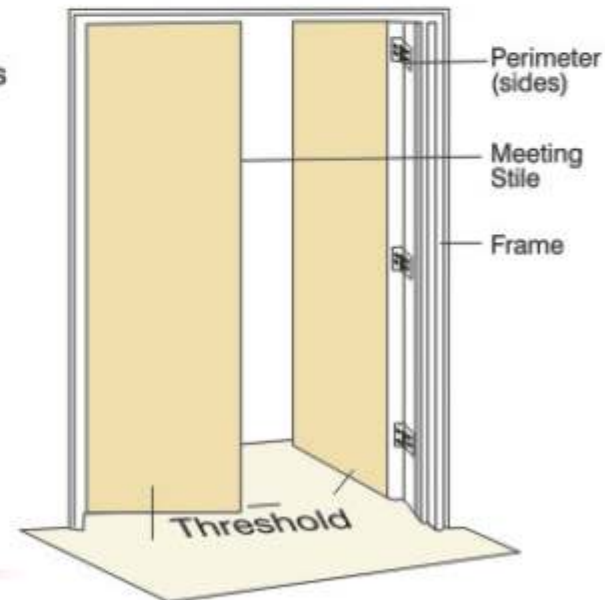

## All our seals .....

- Are manufactured to a **very high standard using high quality raw material.**
- Can be used in **Commercial, Industrial, Public and Residential buildings.**
- Are generally **multi-purpose & can be installed without removing the shutters.**

[www.enviroseals.info](http://www.enviroseals.info)

e-mail : [loto@vsnl.net](mailto:loto@vsnl.net)

For pricing, product details, estimates, samples, installation Procedure etc. e-mail us.

# Brush Strips

For the bottom of the Doors.



This soft BLACK Poly Pile Bristle seal in aluminum carrier adjusts to irregular gaps and is even used over carpets. They provide a very neat sealing solution with the advantage of final onsite installation to overcome unforeseen floor or sill

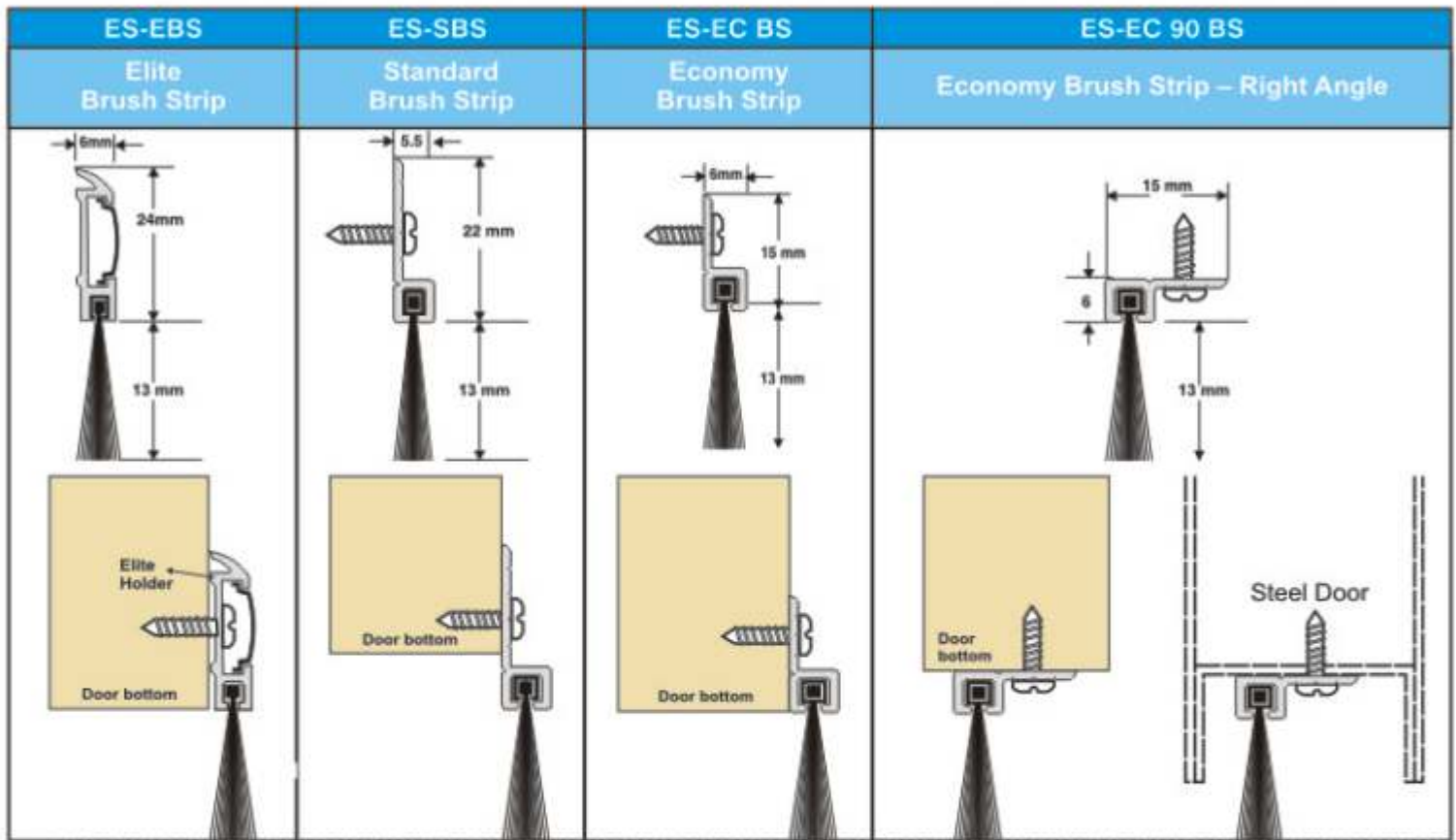

Floor Level

## Various models Available :

- ES-EBS : Elite Brush Strip
- ES-SBS : Standard Brush Strip
- ES-EC BS : Economy Brush Strip
- ES-EC 90 BS : Economy Right Angle Brush Strip
- ES-EBS - 45 : Elite Brush Strip 45 Degree Angular

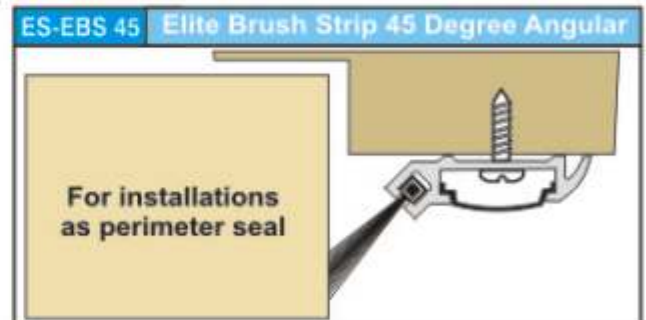

**Location /Application** : Door Bottoms, Door Tops, Single / Double swing Doors or Sliding door, Head of Rollers Shutter Door & Sliding doors.

**Min/Max Gap** : Up to 15 mm.

**Seal lengths** : 3 Feet ,1 meter and 4 Feet sizes are available in white and brown Powder Coated

**They are available up to 12 feet in Raw Mill Finish or in clear Anodized finish .**

**Fixing** : appropriate fixing screws are supplied, slots are being die cut in the profile to allow the seals to be fitted accurately and adjusted as necessary. Elite models are supplied with a flexible PVC cover strip to conceal fixing screws.

# Brush Strip : Various Applications

For Bottom & Sides of the Doors & Windows



These Brush Strips can be installed sideways also on doors & windows, to eliminate the gaps that exists between the sliding doors and frames or between two sliding doors. Number of applications are shown here under.

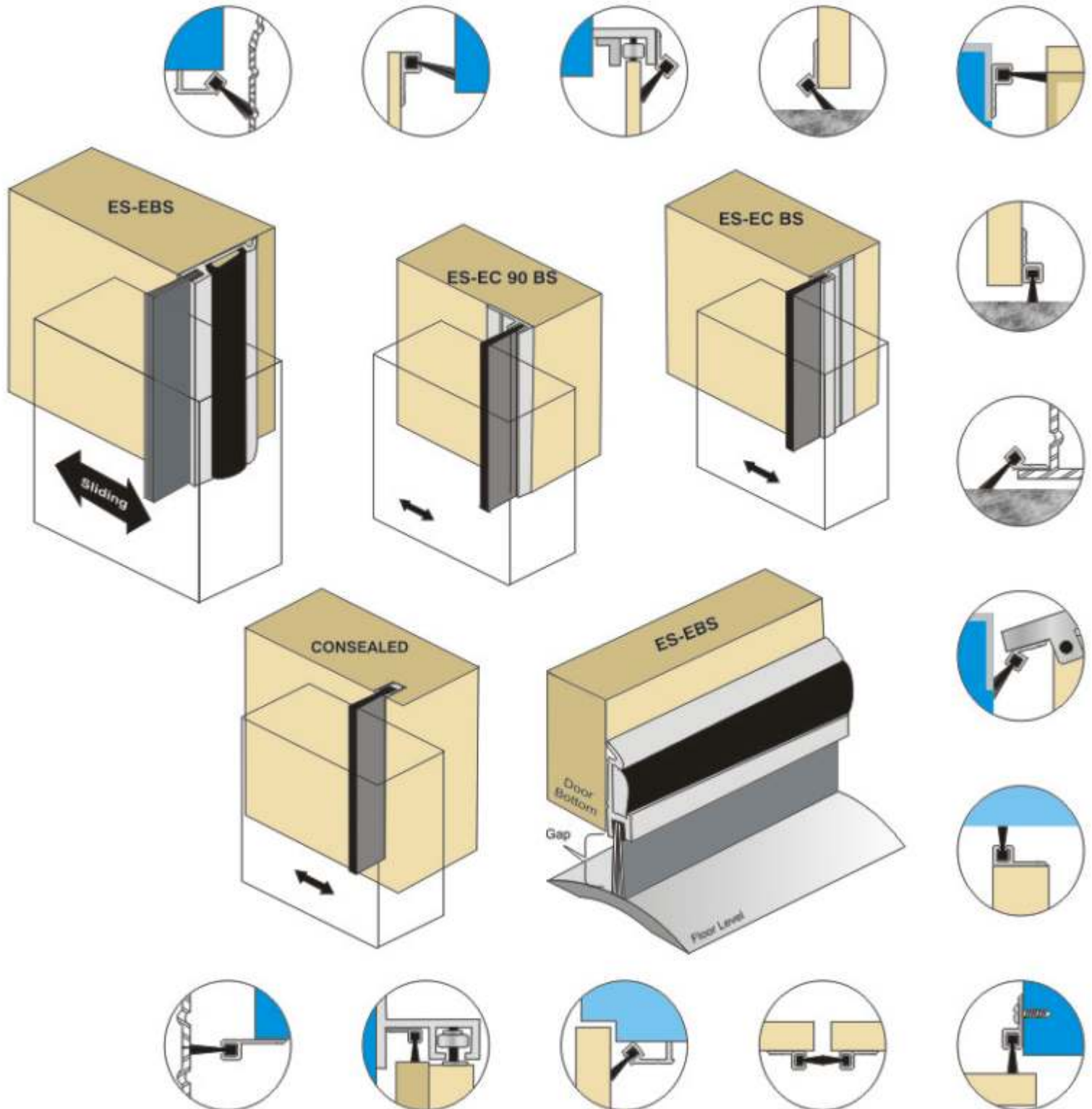

# Concealed Brush Strips

Seal Code: **ES-CBS**

**Enviroseals**  
NEW DELHI

For Bottom & Sides of the Doors



This Brush Strip is fixed after making a groove, in a timber door.

- Location /** : Door Bottom, Sides & Top
- Application** : Single / Double Swing Doors, Head of Rollers  
Shutter Door & Sliding doors.
- Min/Max Gap** : 13 mm
- Lengths** : 3 feet to 10 feet
- Finish** : Aluminium mill finish

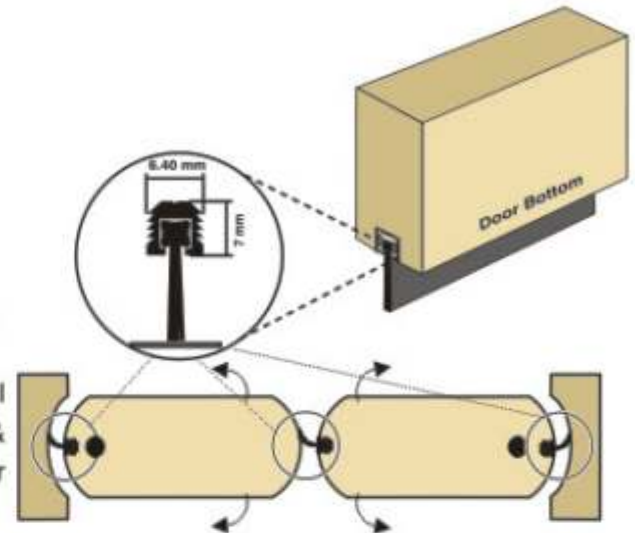

## Floor Hinge Type double side opening doors

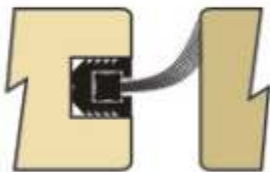

Two way open able, double leaf doors. install **concealed brush strip** on the two sides of door & on the central meeting stile of one door. Order for these seals is given in the same way.

## Co EX Brush Seal ES - COX BR / ES - COX BR-F Co EX Brush Seal with fin

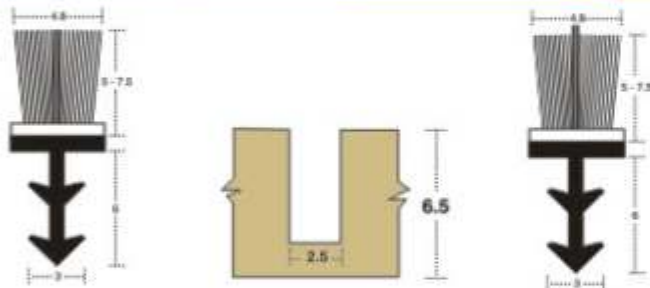

Application on the Timber Windows & Doors.  
Compression Sliding Seal of pile Height 6.5 mm

available in roll form and can be cut to size and inserted.

Black colour.

Choice between -Without the Fin or with Fin Seal

# Rodonil

Seal Code: **ES-RL**

Must for Rodent Problems



This strip has been designed to restrict the rodents like lizards, snakes, scorpions, rats, etc. to enter the room thru the bottom of the door because of the wider gaps, that exist between the bottom of the door and the floor.

**Colour (Elite Holder)** : Powder coated brown / white aluminium strip or anodized aluminium shade

**Insert** : Special grade black poly pile bristles.

**Lengths** : 3 feet, 1 meter & 4 feet

**Min/Max Gap** : 25 MM

Slots are provided in the profile for screwing it at the bottom of the door from the side, (Preferably outside). The aluminum profile can be cut to the width of the door with the help of Hacksaw blade & Black PVC Profile can be cut by any sharp edged Blade. Screws for fixing are provided with this strip.

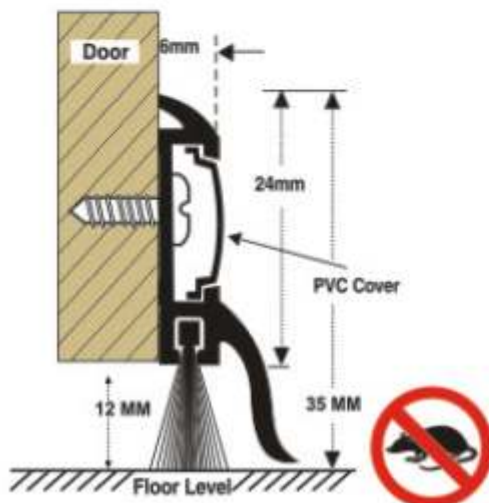

Tel.: (011) 2332 7868, 2371 7868

Fax : (011) 2373 1160

# Nylon Brush Weatherstrip

Seal Code: ES-NBS

Enviroseals  
NEW DELHI

For Industrial or Robust usage



## h Section



- All brush seals consist of densely compressed nylon filaments encased in high quality aluminium retainers.
- These products are ideally suited for hollow metal and wooden door (*in-door sweep, jamb / header gasketing, and split astragal*) applications.
- Also use on overhead doors, sectional doors, sliding doors, and automatic doors, escalator sides, etc.
- All brush seals greatly reduce the infiltration of light, air, wind, rain, and snow; prevent heat loss; control the penetration of smoke and fumes.
- *Black brush strips* are available in *anodized aluminium sections*.
- The dense nylon filaments conform to the contours of every sealing surface, providing a superior seal with extremely low closing force.
- Brush remains flexible down to -40°F and has a melting point above 400°F.
- UV stabilized, dependable, long-lasting, cost-effective.
- All brush seals come with self threading screws.

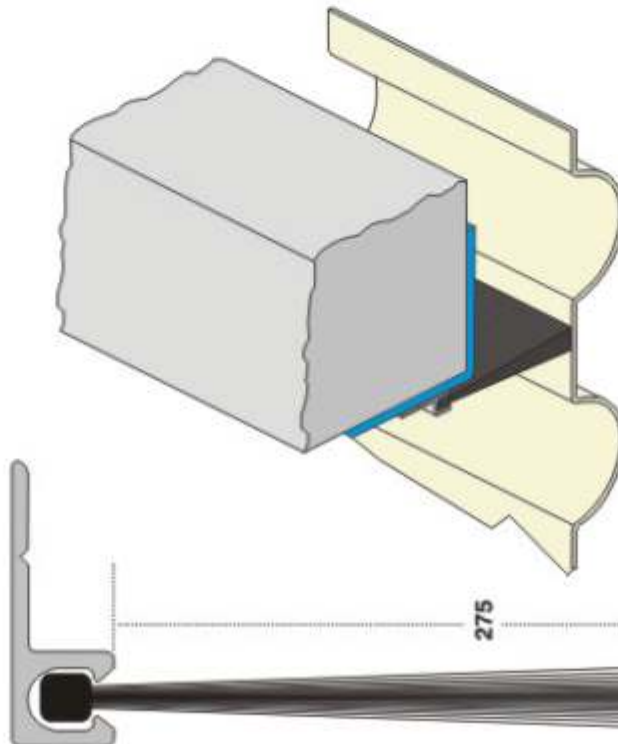

## F Section



[www.enviroseals.info](http://www.enviroseals.info)

e-mail : [loto@vsnl.net](mailto:loto@vsnl.net)

For pricing, product details, estimates, samples, installation Procedure etc. e-mail us.

# Elite Scrapper Strips - Door Sweep

Seal Code: ES-ESS

Enviroseals  
NEW DELHI

For External, Balcony & Bathroom Doors



SS-20 & SS-41 Scrapper Strips have been designed to take care of water problem that arise due to the gaps, that exists between the bottom of the door and the floor, which allows the rain water or the water that splashes on the door and try to enter to the other side through. For example outward opening balcony doors or bathroom doors.

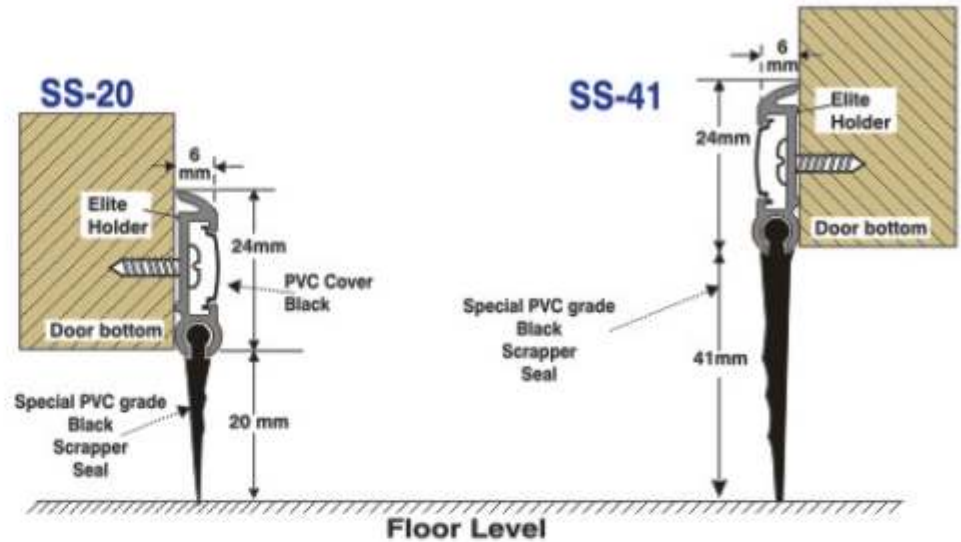

- Colour (Alum. Holder) :** in brown / white / anodised aluminium shade with black cover strip
- Insert :** Special grade Black PVC extruded profile.
- Lengths :** 3 feet, 1 meter & 4 feet
- Min/Max Gap :** 25mm / 45 mm
- Restrict :** Water, dust, insects, light, noise, fumes etc.
- Fixing Method :** Slots in the profile are provided for screwing it at the bottom of the door from the side, (Preferably outside). The aluminum profile can be cut to the width of the door with the help of Hacksaw blade & Black PVC Profile can be cut by any sharp edged Blade. Screws for fixing are provided with this strip.

# Economy Scrapper Strips - PVC

Seal Code: ES-ESS

Brown, White or Clear Co Extruded Strips  
for the Bottom of the Doors



ESSB - Brown

- A dual hard PVC Profile with soft flexible blade.
- Fit at most of the door bottoms.
- Neat aesthetic appearance



ESSC - Clear



ESSW - White

- Colour :** In brown / white / clear transparent
- Lengths :** 3 feet, 1 meter & 4 feet.
- Min/Max Gap :** 5 mm / 18 mm
- Restrict :** Water, dust, insects, light, noise, fumes etc.
- Fixing Method :** Double sided tape is provided at the back of all the profiles for easy and neat installation. Screwing is recommended in case of wooden / metal doors

Tel.: (011) 2332 7868, 2371 7868

Fax : (011) 2373 1160



# Interlocking Seals

Seal Code: **ES-IS**



For Exposed Doors & Windows

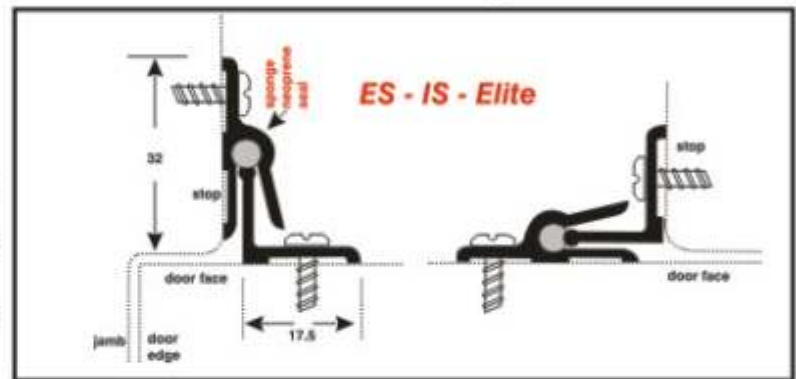
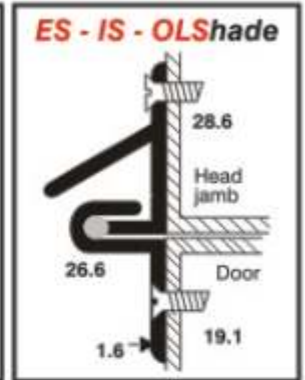
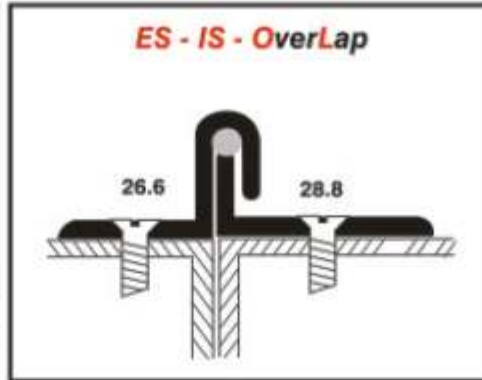
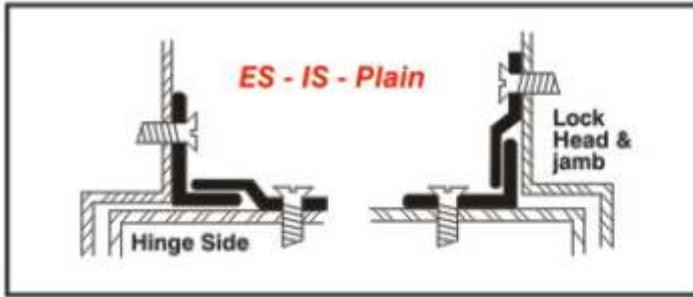

- Best solution for the outward / inward opening doors / windows where the canopy is not provided.
- Fits to most of the doors / windows.
- Neat aesthetic appearance

**Colour** : Clear Anodized finish  
**Lengths** : Various door sets are available - ask for details  
**Restrict** : Water, dust, insects, light, noise, fumes etc.  
**Fixing Method** : Slots in the profile are provided for fixing them to the frame and the Door.

# Threshold Door Stopper

Seal Code: **ES-TDS**

Combination of Aluminium and Soft PVC / Silicon Profiles.  
 for the Bottom of the Doors

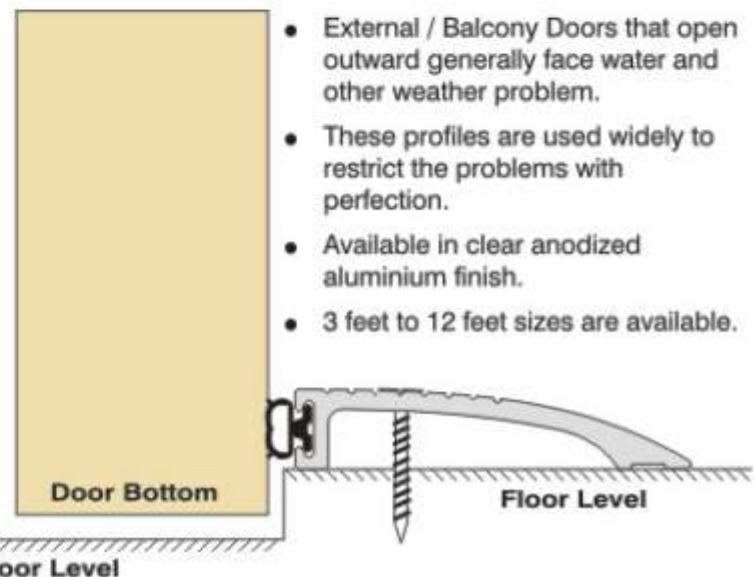
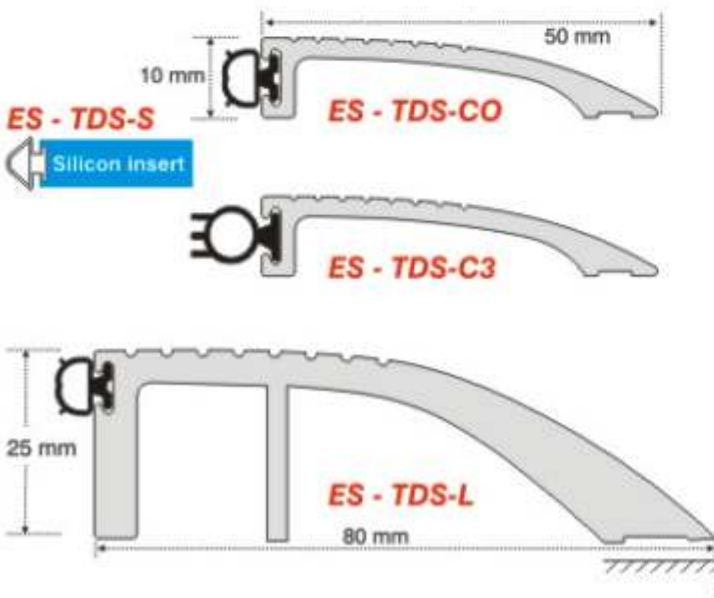

- External / Balcony Doors that open outward generally face water and other weather problem.
- These profiles are used widely to restrict the problems with perfection.
- Available in clear anodized aluminium finish.
- 3 feet to 12 feet sizes are available.

## Rain Water Seals

Seal Code: ES-RWS

Enviroseals  
NEW DELHI

For the bottom of external doors and windows



This strip has been designed to restrict the rodents like lizards, snakes, scorpions, rats, etc. to enter the room thru the bottom of the door because of the wider gaps, that exist between the bottom of the door and the floor.

- (Elite Holder)** : Powder coated brown / white aluminium strip or anodized aluminium shade
- Insert** : Special grade black polypile bristles.
- Lengths** : 3 feet, 1 meter & 4 feet - till 12 feet lengths.
- Min/Max Gap** : 25 MM

### Seal Code: ES-RWDS Rain Water Drip Seal

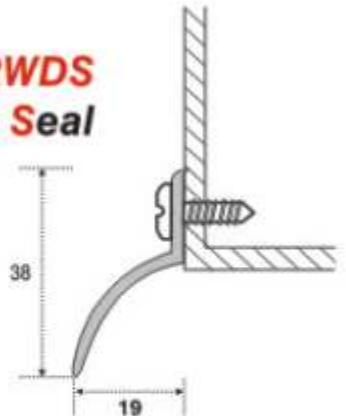

Slots are provided in the profile for screwing it at the bottom of the door from the side, (Preferably outside). The aluminium profile can be cut to the width of the door with the help of Hacksaw blade & Black PVC Profile can be cut by any sharp edged Blade. Screws for fixing are provided with this strip.

## Rain Water Canopy Seals

This strip is designed to channel rainwater away from exposed doors & windows, particularly those which open outward.

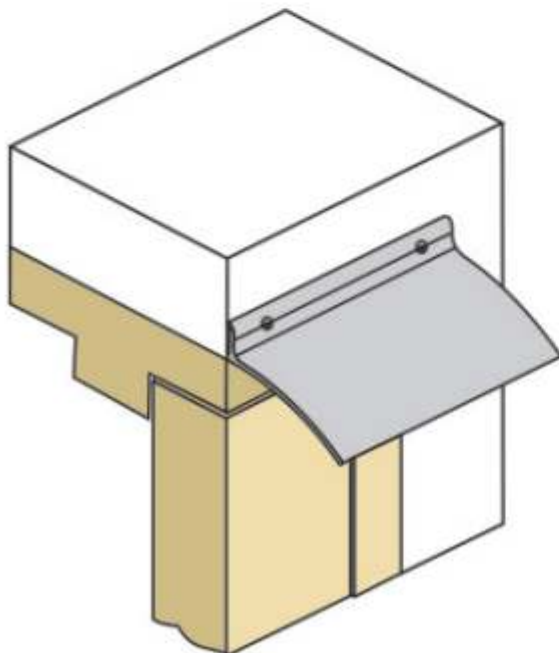

Perfect Canopy for outward or inward opening Doors / Windows

**Position** : Above the doors / windows.

**Location** : Single swing, double swing, sliding, etc.

**Lengths** : 1m and 2.25m.

**Fixing** : Appropriate fixing screws are provided, fixing holes are not pre drilled, allows an overlap of 75 mm each side of door/window opening.

### Seal Code: ES-RWCS

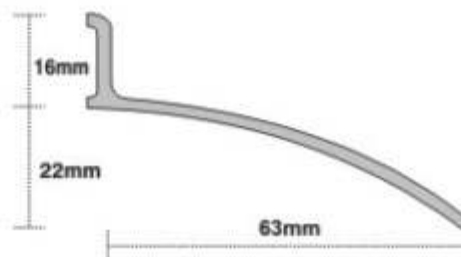



- Autorise Drop Seals are well accepted in most of the areas where the problem of Dust, Insects, Rain Water, Leaves, Rodents, A/C Loss etc is omnipresent. At every door where the installation of scrappers or any fixed seals is not possible - THIS IS AN IDEAL SEAL.
- Tried and tested from the last 15 years in India.
- Manufactured from durable aluminium, super grade flexible seal, stainless steel springs.
- Absolutely no restriction to the floor.
- Can be used anywhere, completely safe for all pedestrians.
- Equally effective on internal or external Doors - on inward or outward opening doors.
- The unique action provides a lift of around 16 mm to clear the floor covering.
- As the door is opened, the hinged flap rises to clear the threshold and tilts down to form a positive weather proof cushion when the door is closed.
- Available in variety of finishes & sizes.

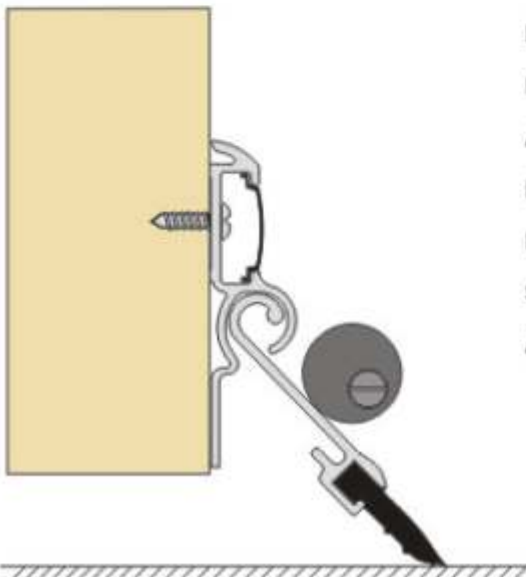

<b>Location</b>	: Single and double, butt Hinged doors.
<b>Max Gap</b>	: 25 mm
<b>Available Size</b>	: 15" to 48" . (Custom sizes can be made and supplied.)
<b>Finish</b>	: Clear Anodized / Powder coated white / Brown
<b>Fixing Method</b>	: Screws supplied with every seal.
<b>Seal Material</b>	: Special flexible PVC Profile.
<b>Adjustment</b>	: Adjustment of the profile is being done by rotating the Black adjustment round block - which is installed on the Door Frame.

# SideO – Perimeter Astragal Weather Seals

For Doors and Windows



- Perimeters around the doors and meeting stile gaps on pairs of double doors are the **greatest source of drought, dust, heat loss and noise intrusion** in today's modern buildings.
- **SideO seals** can be easily fitted on these doors. They are cost effective solutions - one can recover the cost of their installation within a short span of time in the form of energy costs saved in heating / Central Air conditioning bills.
- These seals **can be installed at site without removing the doors or windows**.
- **Meeting stile / Astragal seals** are either in bulb, blade or brush seal form. Most seals are provided with slotted holes to allow minor adjustments at the time of installation.
- We offer a range of seals, suitable for residential / light commercial applications. Heavy duty commercial seals for thermal and acoustic applications are also available.
- Most Seal inserts are replaceable in the event of wear & tear.



## Enviroseals high grade silicone bulb seal offers :-

- End use temperature range of -30°C to +90°C (+200°F).
- Excellent compression recovery.
- Unaffected by sunlight, ozone and ultraviolet light.
- Fungi resistant & Self extinguishing.
- Encased in high quality aluminium carrier.
- Excellent resistance to infiltration of light, air, dust, smoke, wind, rain and snow.
- Conforms well to irregular, distorted, flexing or sliding surfaces.
- Effective thermal and acoustic properties.
- Cost effective.

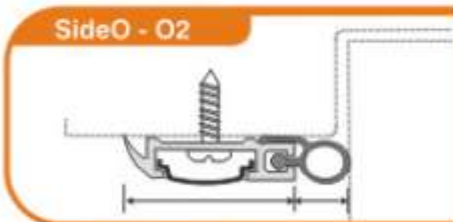
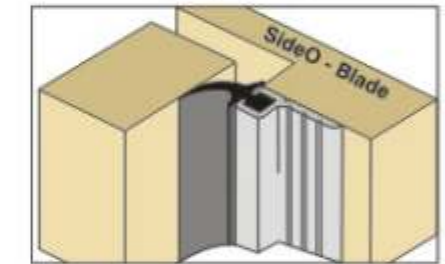
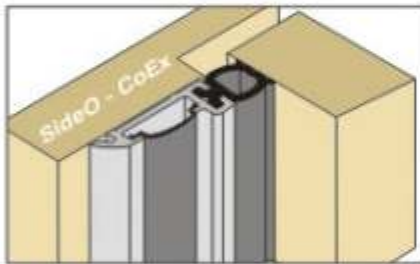
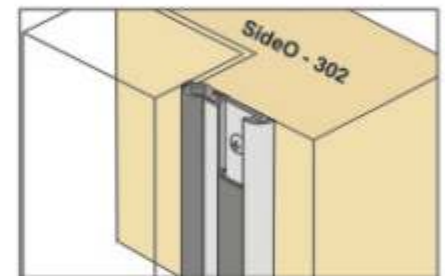

## SideO : Side Pattern

**Location** : Sides of the Hinged / sliding Doors / Windows

**Min/Max Gap** : 1 - 8 mm

**Seal material** : PVC / Silicon / brushes

**Fixing** : Slots are being provided for screwing

**Available** : in clear anodized / powder coated or raw aluminium mill finish

**Lengths** : Single Door :  
1 x 1 meter + 2 X 2.2 meter

**Double Door** : 3 x 2.2 meter lengths

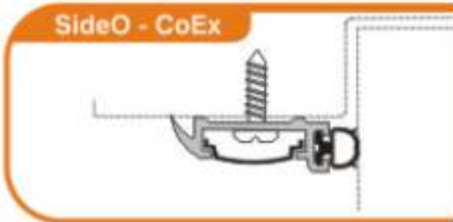
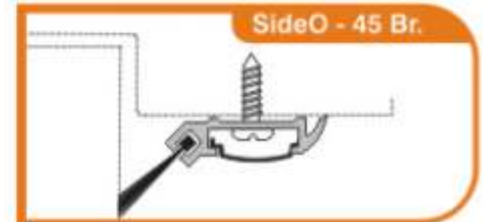
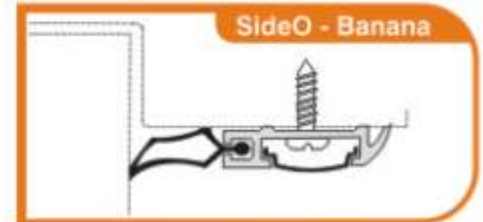
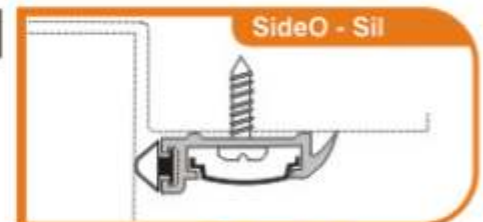

# Astragal / Meeting Stile Weather seals

For Doors and Windows



Astragals / Meeting stiles on double doors often present problems because of complex conditions and requirements. Enviroseals offer simple and inexpensive solutions. Each situation should be carefully studied for its specific requirement while selecting the appropriate seal.

Please Note that some astragal profiles consist of two parts, one for each door, and should be ordered in double lengths.

**Astragal - D O2**

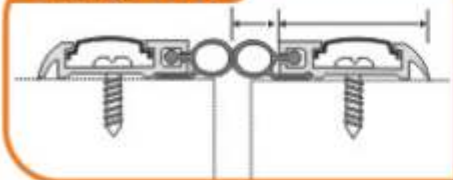

**Astragal - D sill**

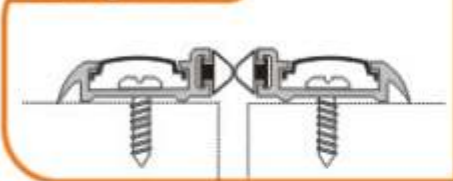

## SideO : Center Pattern

- Location** : Centre Verge of the doors
- Min/Max Gap** : 1 - 18 mm
- Seal material** : PVC / Silicon / brushes
- Fixing** : Slots are being provided for screwing
- Available** : in clear anodized / powder coated or raw aluminium mill finish
- Lengths** : For center only 2 X 2.2 meter For all the sides 5 X 2.2 meter lengths

**Astragal - D 302**

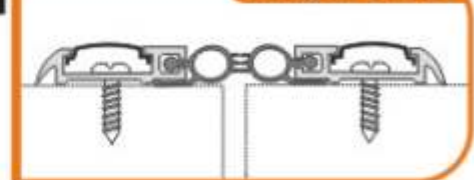

**Astragal - D Br.**

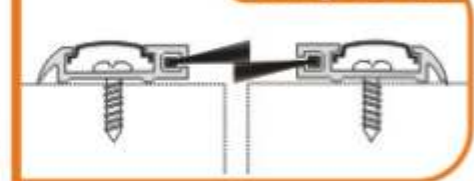

## Centro L Profiles For Centre verge of the doors



### ES-CLPS

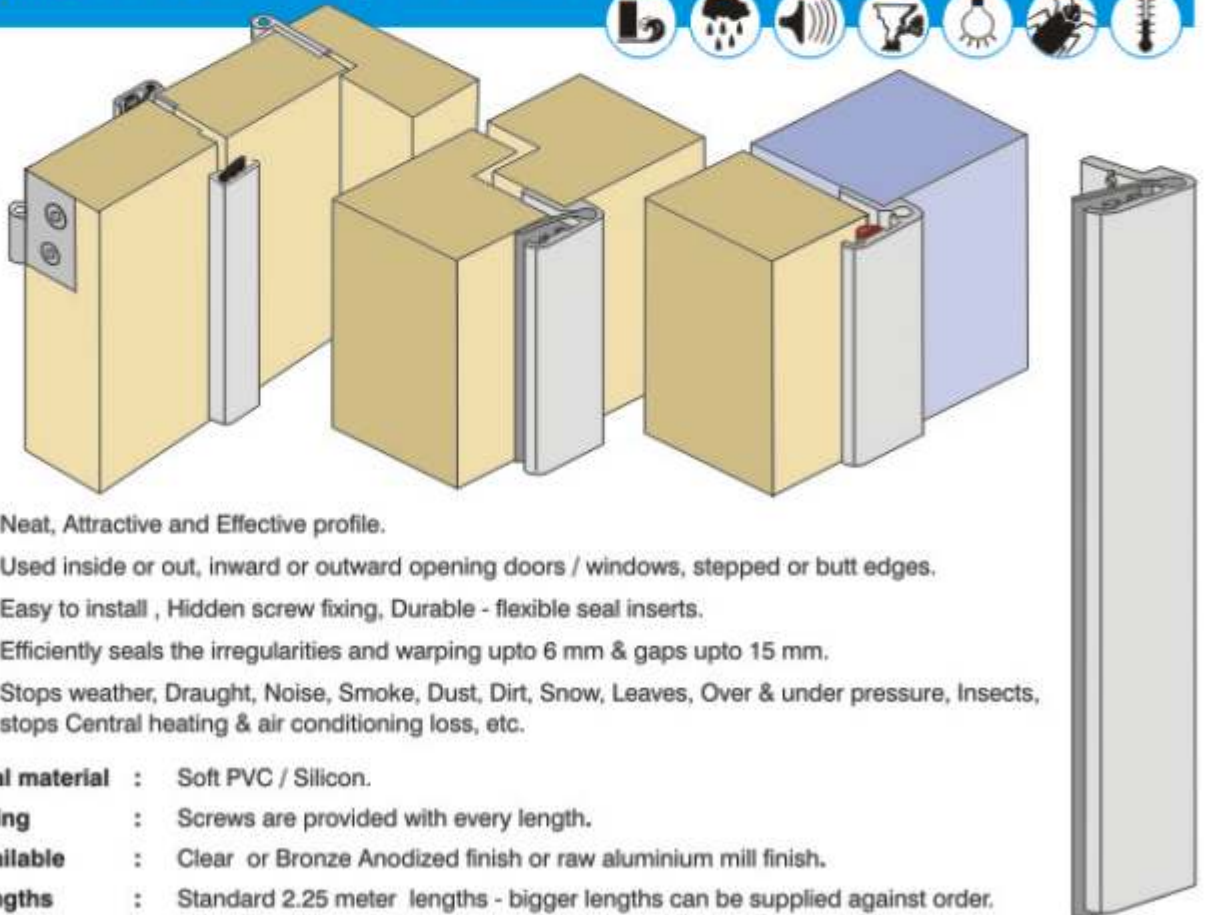
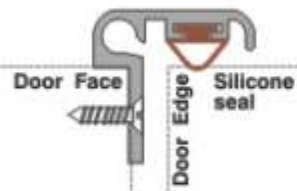

### ES-CL 45

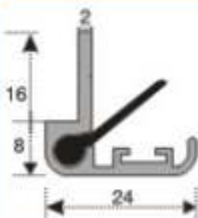

### ES-CL COEX



- Neat, Attractive and Effective profile.
- Used inside or out, inward or outward opening doors / windows, stepped or butt edges.
- Easy to install , Hidden screw fixing, Durable - flexible seal inserts.
- Efficiently seals the irregularities and warping upto 6 mm & gaps upto 15 mm.
- Stops weather, Draught, Noise, Smoke, Dust, Dirt, Snow, Leaves, Over & under pressure, Insects, stops Central heating & air conditioning loss, etc.

- Seal material** : Soft PVC / Silicon.
- Fixing** : Screws are provided with every length.
- Available** : Clear or Bronze Anodized finish or raw aluminium mill finish.
- Lengths** : Standard 2.25 meter lengths - bigger lengths can be supplied against order.

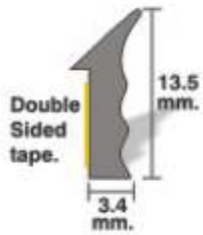

## Must for every door and window with glass panel

### Features :

Installation of Timberglaze is must on both the sides of the glass to avoid water penetration in case of heavy rains.

- Timberglaze is a closed cell Black Colour, EPDM seal.
- It's a proven, durable and long life profile.
- Being adhesive backed, it ensures fast and simple installation in fixing glass in timber doors / windows.
- Resistance to UV light and weather within a wide temperature range.
- Unaffected by normal applications of paints & Polishes .
- Prevent : AC Leakages, Dust, Rain Water, Vibration, etc.

- Location** : Between the Glass and the wooden frame / beading.
- Seal material** : Closed Cell EPDM ( Ethylene Propylene Diene Monomer ) Black Profile.
- Lengths** : Available in 100 meter rolls.
- Fixing** : Integral double sided adhesive tape.

**Timberglaze : must be installed on both sides of the glass**

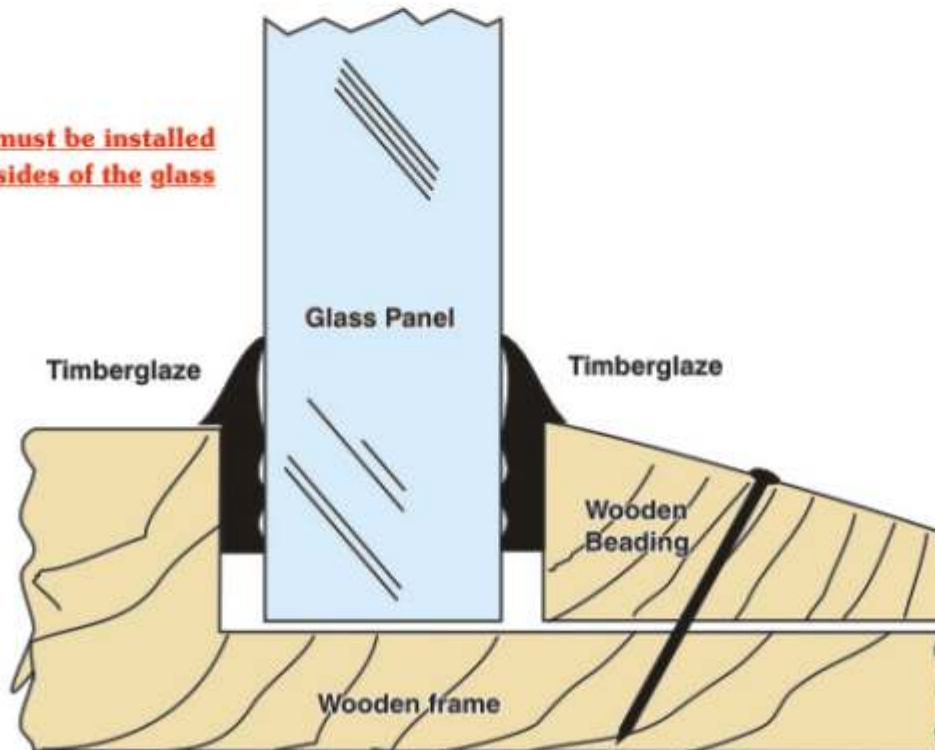

For 10 & 12 mm Glass Doors



These seals are designed for frameless glass doors.

- Location** : Meeting stiles and jambs of double swing and frameless sliding glass doors.
- Min/Max Gap** : 5 - 8 mm
- Seal material** : Poly pile bristles - Black
- Lengths** : 1m and 2.25m.
- Fixing** : Integral double sided foam adhesive tape.
- Available** : COS -10 for 10mm thick glass,  
COS -12 for 12mm thick glass.

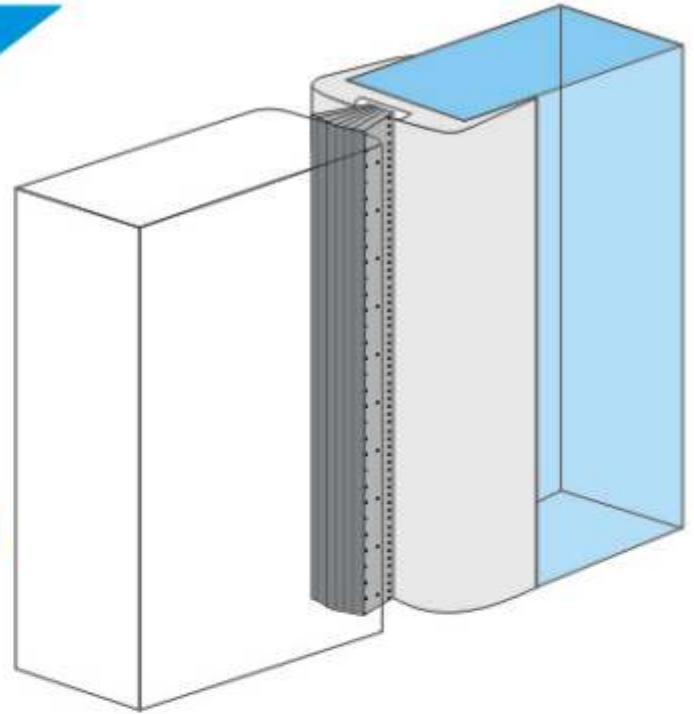

**CO-10**

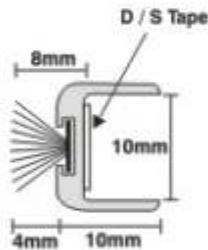

**CO-12**

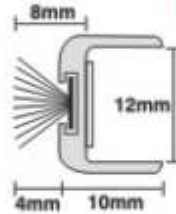

## Clip-On seal - Clear PVC - Co extruded

Seal Code: **ES-COPS**

**CO-1**

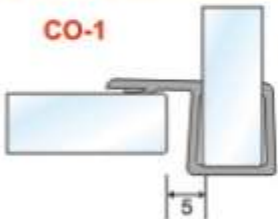

**CO-2**

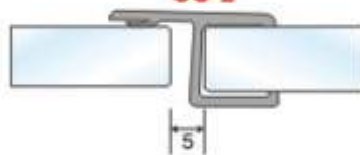

**CO-3**

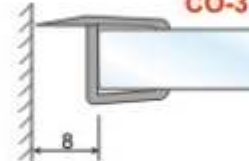

**CO-4**

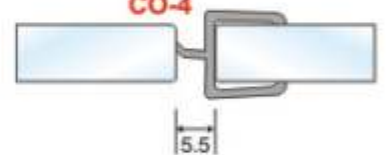

**CO-5**

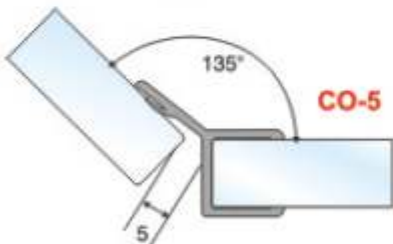

**CO-6**

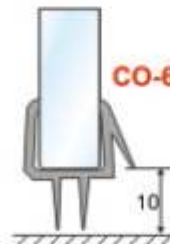

**CO-7**

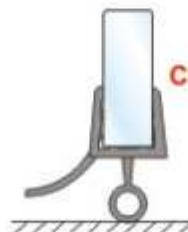

**CO-8**



**CO-9**

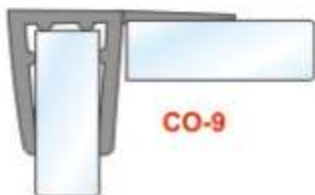

**CO-10**



**CO-11**



For technical details - e mail us your requirements



All CATS / DROP SEALS consists of aluminium casing which surrounds a movable drop bar seal. This bar is actuated by a plunger, which contacts the frame of the door while closing - forcing the drop bar to seal against the floor or threshold. Their low closing force actuation does not allow it to conflict with the operation of door closer operation. Installation is quick and easy. Their symmetrical case provides even flush mounting in case of CATS - 4

Available in sizes from 450 mm to 2500 mm ( any size made to order ).

In other words - These drop seals are concealed under the door by making a groove. They lift themselves as soon as the door is opened by few millimeters & come down and seal the gap as and when the door is closed.

They operate automatically once the black button (adjusting screw) comes in contact with the door frame.

They can also be fitted into the bottom rail of a Timber, Steel, Aluminium or Composite Doors by the fabricator. These seals have been tested for their durability for more than 5,00,000 times, without failure.

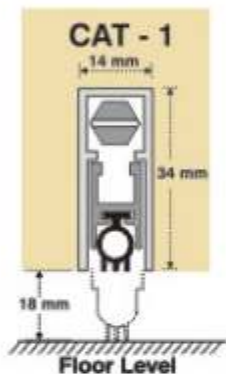

### CATS 1 & 2

**Location** : Single and double, butt Hinged doors.

**Min/Max Gap** : 3mm / 14mm

**Seal Size** : 9" to 2.5 METERS . (Custom sizes can be made and supplied.)

**Finish** : Clear Anodized Finish

**Fixing Method** : Concealed, with supporting Side Clamps / Screws supplied with every seal.

**Seal Material** : PVC (Black) or Silicon

**Adjustment** : Adjustment Screw is provided in every profile for adjusting the movement of the lower portion of the seal.

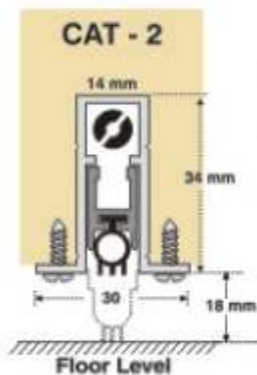

### General Applications of CATS :

- For exclusion of Dust, Draught, Moisture, Insects, Smoke, Fumes, Light, Sound etc.
- All exterior doors of Shops, Commercial Offices, Banks, Public Buildings, Hospitals, etc.
- Hotel / Motel rooms guest room doors , interconnecting doors, Consulting rooms, Board rooms, Surgeries - Operation Theaters, Management Offices, BPO's, Factories / Shop floors, Engineering Tool rooms Computer Rooms, Hub Rooms, Electrical Control Rooms
- Plant /Boiler / Lift and Pump Rooms \* Clean Rooms, Interlocking Doors and Laboratories
- Class rooms and Libraries \* Photographic and Dark rooms \* Art and Theater / Drama Studios
- Sports Rooms and Gymnasiums. Museums \* Cool / chiller rooms, etc. Best installation are with Threshold Plates.



Smooth Positive Action Mechanism



**CATS- 3 ST**  
Standard



**CATS- 3 FG**  
Flexible Grey

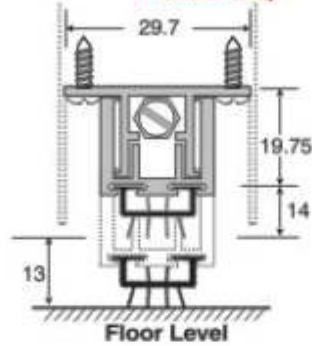

**CATS- 3 CE**  
Co-Extruded

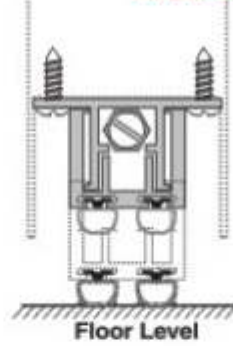

**CATS- 3 SL**  
Silicon

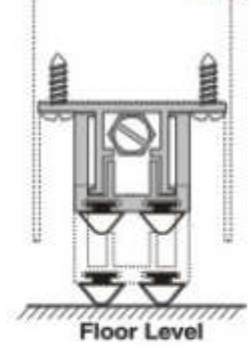

- Location : Single and double hinged doors
- Min/Max Gap : 1 mm / 15 mm
- Sizes Available : 500 mm to 2000 mm. ( customized as per requirements )
- Standard Finish : Anodized Satin Clear / Mill finish
- Fixing Method : Screws of the appropriate size are provided with every seal.

Proper sealing of doors involve more than one profile. This is a Widely Accepted Combinations of seal.

SideO-302

CATS-1

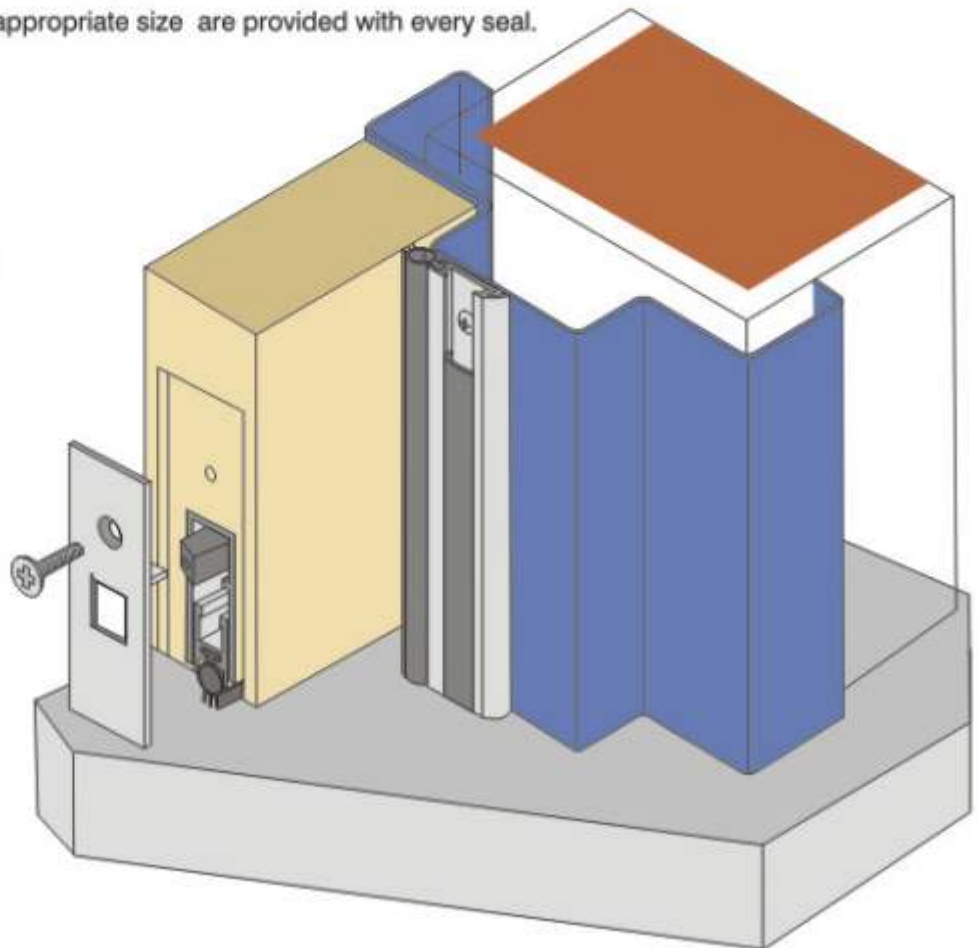
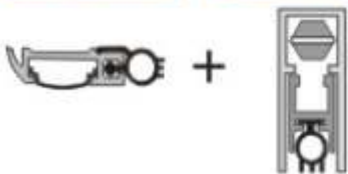



**CAT- 4 Activation**

**CATS - 4** was launched after getting the feed back from our customers as they wanted to have these drop seals for their existing doors and wanted to install them without removing the doors or without making a groove in them.

Exposed Face Mounted Automatic Drop Bottom seal with unique concealed fixing method this profile is spring loaded to lift clear of the floor as soon as the door leaf is opened by a few millimeters. It is operated automatically by pressure against the door jamb on its adjusting screw

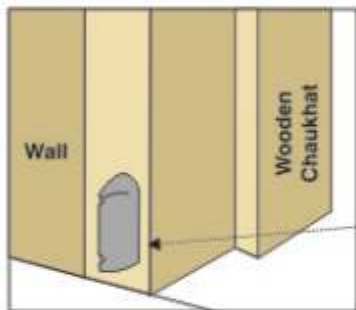
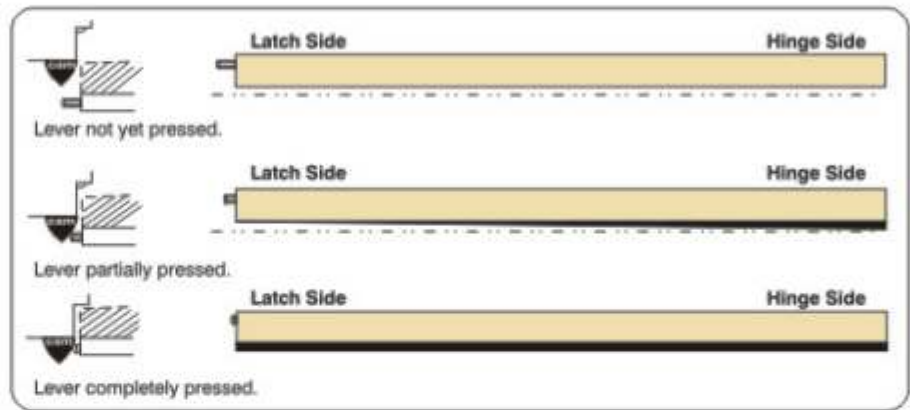
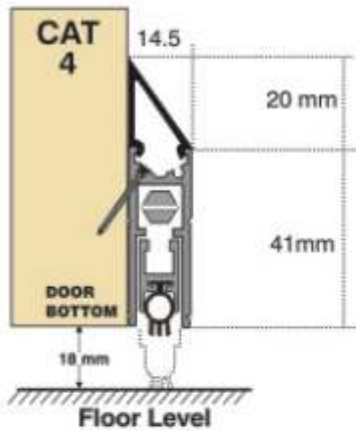

View of **Cam** installed on exterior latch side of door jamb (Chaukhat).

**Side-A**, installed from the inner side of the door

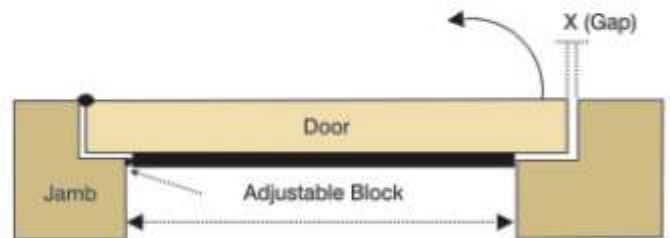

**Side-B**, installed from the outer side of the door

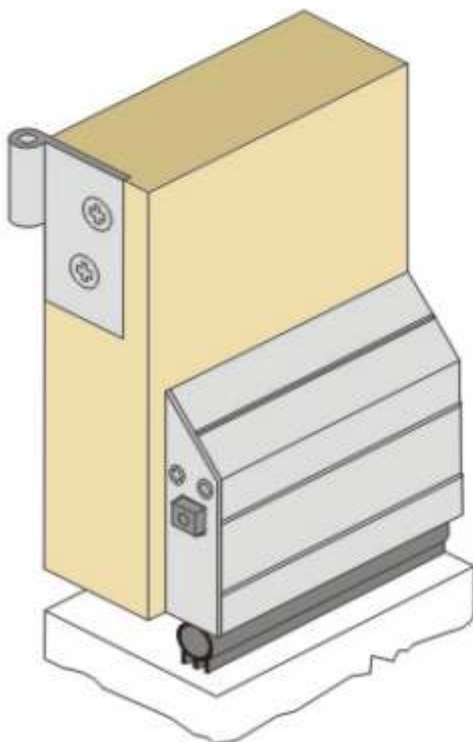
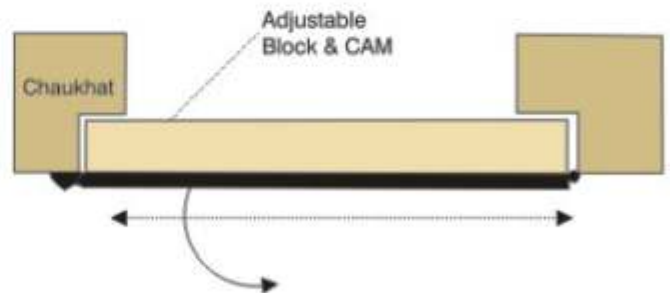

**Location** : Single and double hinged - **Timber or Metal Doors.**  
Inside or Outside application .

**Min/Max Gap** : 1 mm / 20 mm

**Sizes Available** : 500 mm to 2000 mm. ( customized as per requirements )

**Standard Finish** : Anodized Satin Clear / Bronze Finish

**Fixing Method** : Screws of the appropriate size are provided with every seal.

*For the Bottom of the Doors*



**Economy Model** in the Drop Seals category for normal Household / Daily use doors .

- Location** : Single and double, butt Hinged doors.
- Min/Max Gap** : 3mm / 14mm
- Seal Size** : 9" to 2.5 METERS . (Custom sizes can be made and supplied.)
- Finish** : Clear Anodized / Mill Finish
- Fixing Method** : Concealed, with supporting Side Clamps / Screws supplied with every seal.
- Seal Material** : **Special Co extruded PVC Profile.**
- Adjustment** : Adjustment of the profile is being done by rotating the nut clock or anti clock wise.

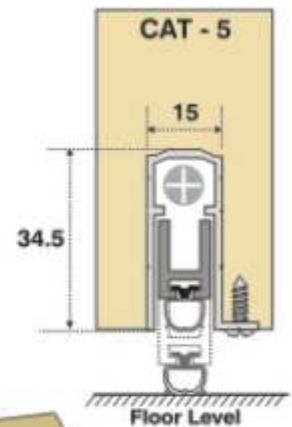

**In case of Double door : installation Pattern - side ways or in the center - concealed versions - CAT - 1,2,3,5,6.**

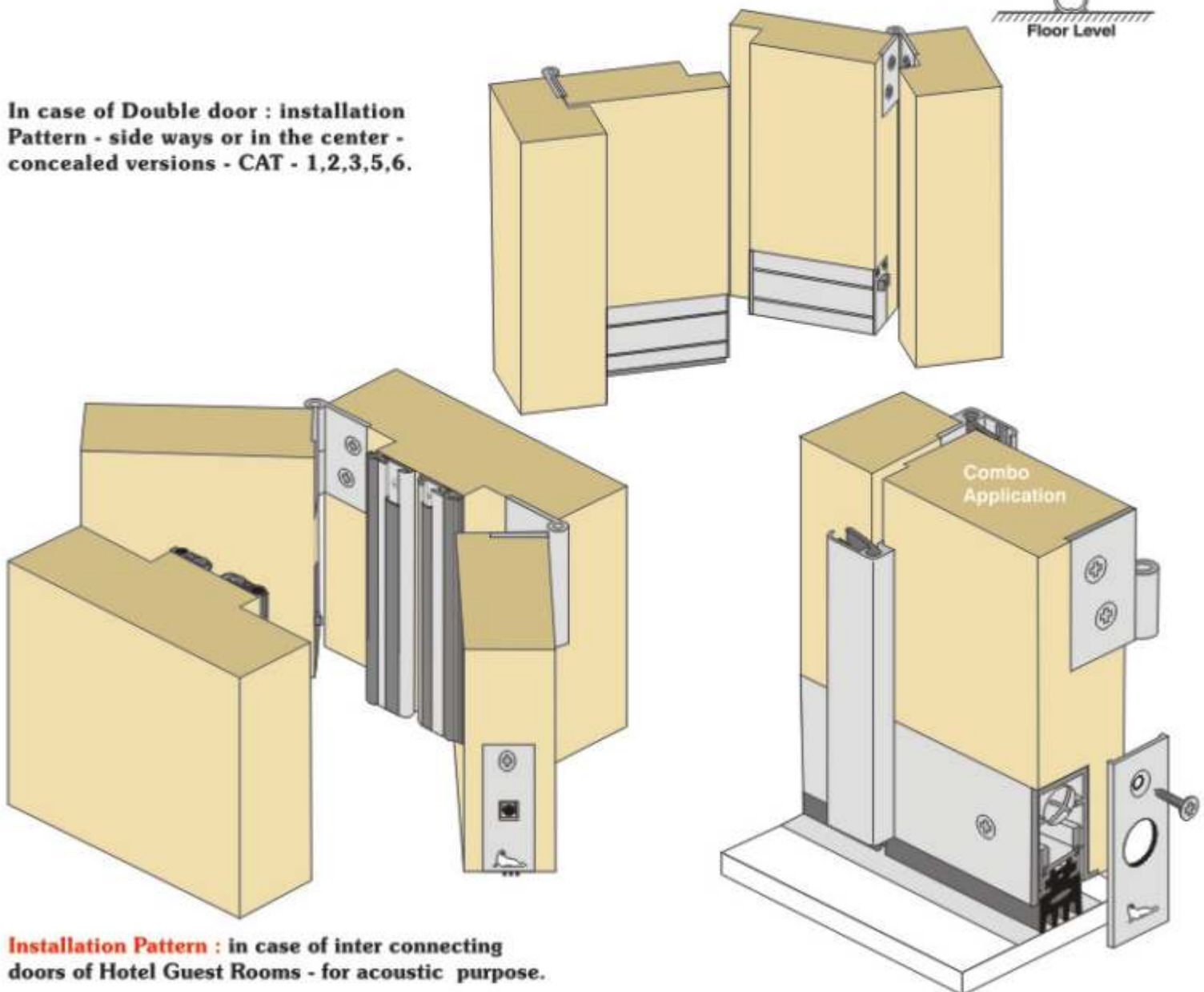

**Installation Pattern** : in case of inter connecting doors of Hotel Guest Rooms - for acoustic purpose.

For the Bottom of the Doors



The Simple, yet practical engineering of all the mechanism include the following features.

1. When the plunger contacts the frame, the drop bar actuates from Multiple Compression points
2. The plunger require Feather Touch closing force to actuate the drop bar seal.
3. The drop bar seal actuates on the hinge side first.
4. The four finned sponge closed cell neoprene seal is being used in these model of CATS.

These seals are excellent in keeping out Dust, Smoke, Drought, Fumes, Light, and other environmental problems.

They can be installed in the wooden & Hollow metal doors.

End plates are supplied with most of the CATS.

Available in sizes from 14" to 8100 inches.

**Customized sizes can be supplied without any extra charge.**

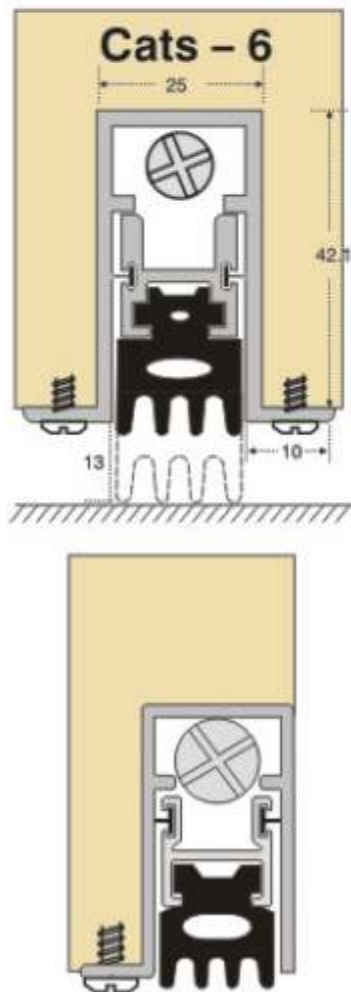
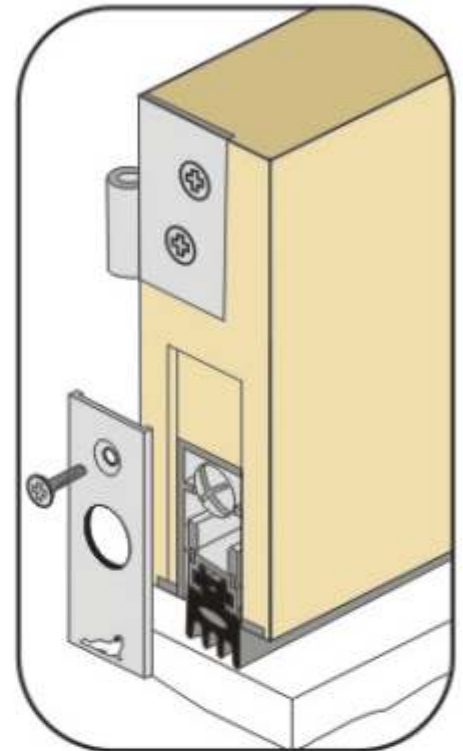

### Acoustic Sound Seal Systems

Effective suppression of noise and sound is a key factor in today's environment where locations such as Malls, Cinema Halls, Studios, factory workshops, tool rooms, hotels, banks, boardrooms, interview and doctors surgeries are all examples of situations benefitting from efficient acoustic control.

Correct selection of materials in the construction of floor, walls and ceiling are initially essential but it is invariably the doorway which offers the most noticeable weakness in permitting sound

to 'intrude' or 'escape'. For critical applications i.e. recording studios, the use of high quality purpose made door and frame sets are essential but for other everyday situations even a modest good quality solid core timber door with acoustic seals may be suitable to prevent sound intrusion from one location to another.

The entire perimeter of the door is effectively controlled by a combination of threshold, automatic door bottom seal and appropriate perimeter compression seal.

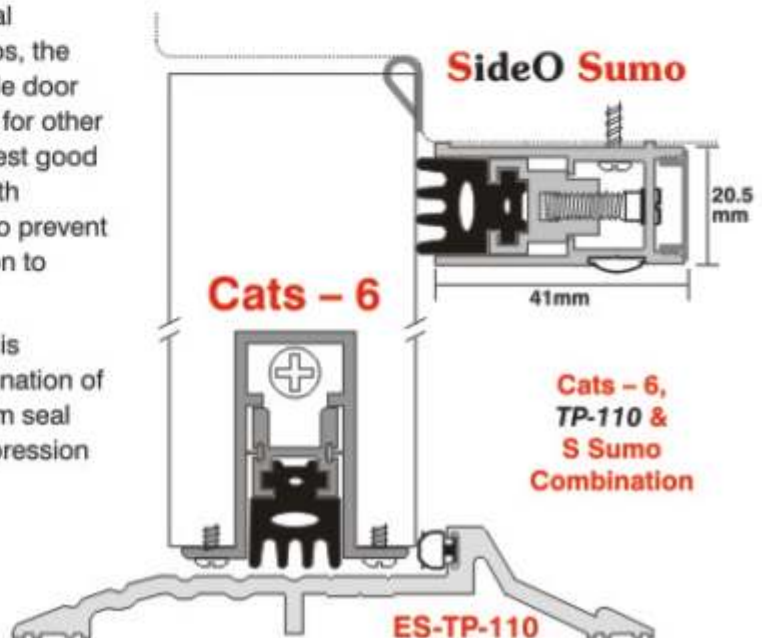

# Threshold Plates

Seal Code: ES-TP



For all kinds of Doors.

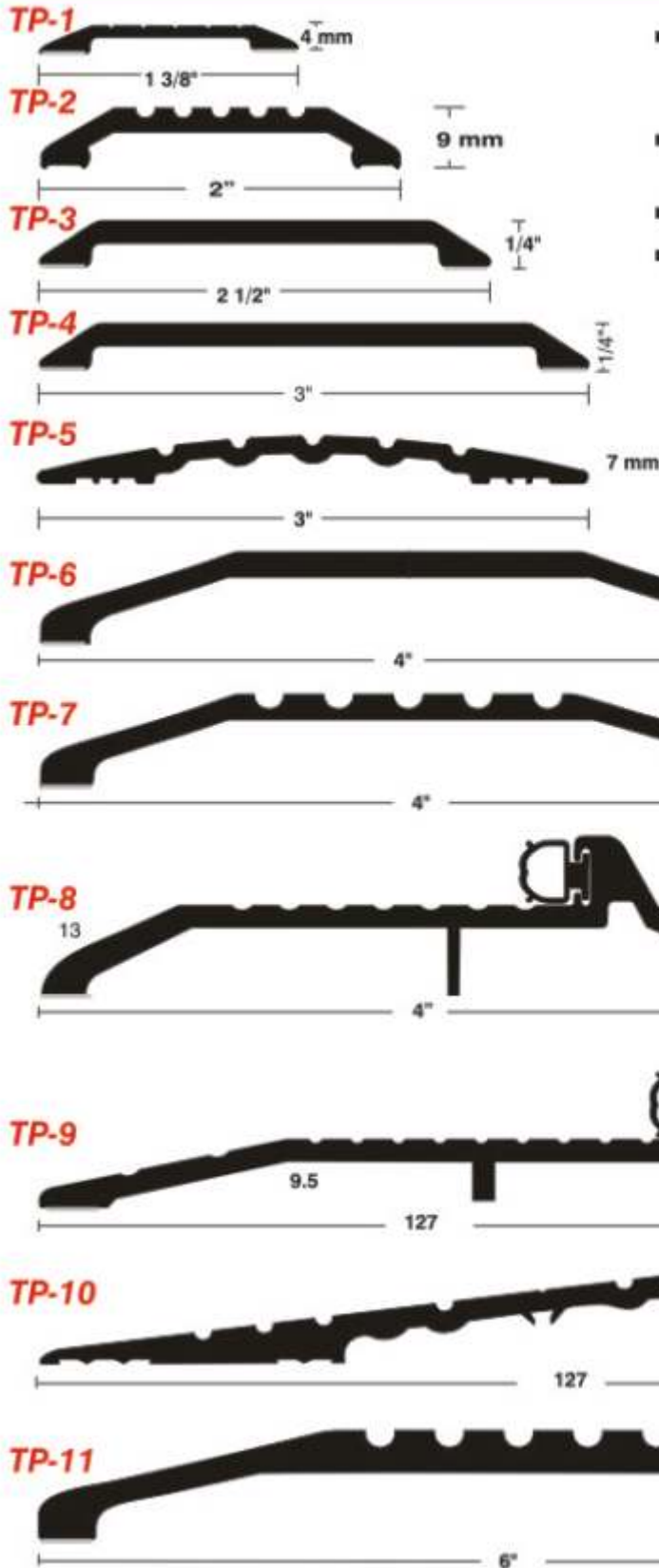

- Threshold plates are always recommended for perfect installation of door bottom seals. They are available in wide variety of styles and sizes.
- They are being sized in mm and in inches to facilitate all type of customers.
- Details on each product is available on request - by e-mail.
- They are also known as **saddle profiles**.

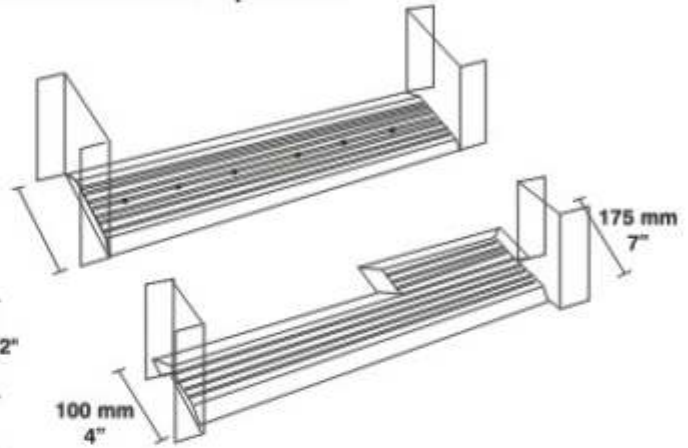

# SideO – Silicon Self Stick Seals

Seal Code: ES- S-10



For all kinds of Doors and Windows.



S - 10 T

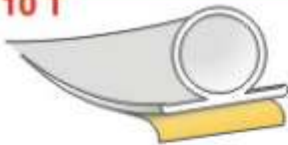

Pressure Sensitive Adhesive Tape

S - 10 B

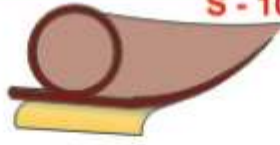

- The Most preferred and accepted perimeter self stick Silicon seal in India
- Durable and easy to install.
- Best self adhesive tape used for superior and lasting bonding to any surface.
- Excellent shape memory.
- Available in Clear Transparent and Brown colour
- Available in 100 meter rolls

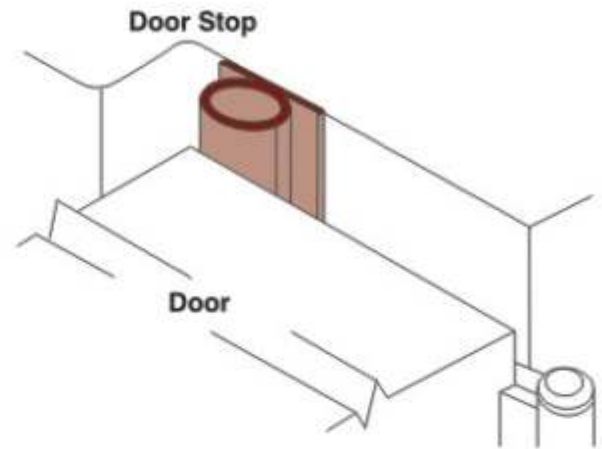

# TwinOO Seal

Seal Code: ES- TwinOO

Most Durable Silicon Seal for Wooden Doors & Windows

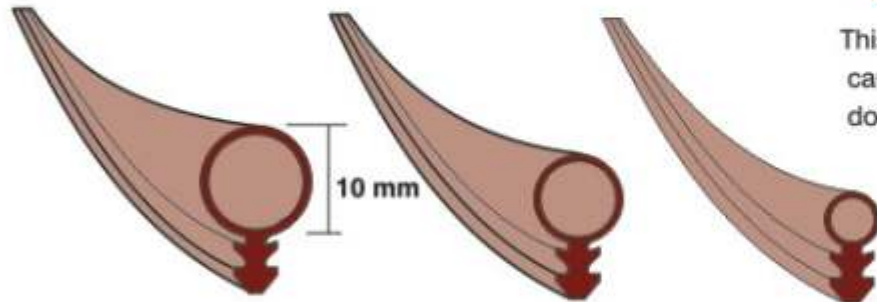

This internationally best **silicon based Twinoo Seal** can be installed after making a groove in the frame of door window.

<b>Material</b>	: Superior Grade Silicon
<b>Colour</b>	: Brown & Transparant
<b>Size</b>	: 5mm, 8mm & 10mm
<b>Roll Lengths</b>	: 5m, 25m & 100m.

Angular Pattern

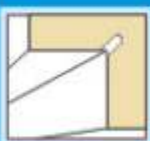

## Installation :

On the hinge side (frame)  
In case door is already installed

- 1 Make a groove in the frame.
- 2 Insert Twinoo Seal in the groove and press.
- 3 Seal will remain intact for life time without even using the nails or any adhesive.

Side Pattern

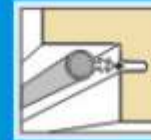
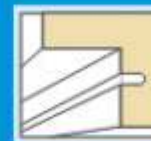

**Must for handling Dust /  
Smoke / Light / Insects /  
Temp. / Water problems.**

Tel.: (011) 2332 7868, 2371 7868

Fax : (011) 2373 1160

# SideO – Self Stick EPDM SEALS Seal Code: ES-EPDM



For all kinds of Doors & Windows.



**SideO - EPDM** are Superior quality **EPDM** ( Ethylene Propylene Diene Monomer ) Self-Adhesive weatherstrips for door and window frames. They provide a compression sealing and are available in White, Brown or Black colours.

- Location /** : Between the door stop and frame of single swing door / widows. (inward / outward)
- Min/Max Gap** : 1mm - 8mm
- Lengths** : 100 mtr. rolls
- Fixing** : Self adhesive, contact surfaces must be clean, smooth & free from dust & oil. If painted, it should be well cured / dried - **Nailing is recommended on the corners because this profile comes in the form of rolls..**
- Material** : EDPM closed cell sponge.

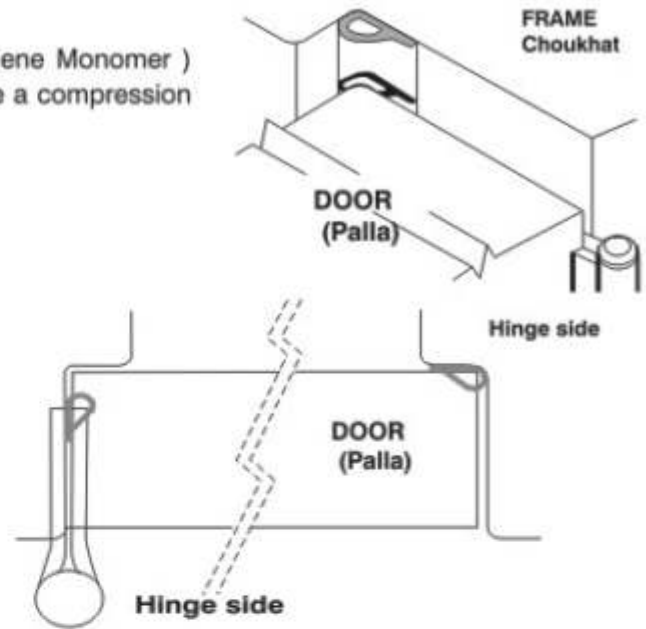

Types	For Gaps (Sizes)	Colours available
'Eee' Seal	For gaps of 2.3 to 5 mm	White / Brown
"Pee" Seal	For gaps of 3 to 5 mm	White / Brown
'Dee' Seal	For gaps of 3 to 5 mm	White / Brown
'Cello' Seal	For gaps of 3 to 6 mm	Brown
'All Round' Seal 10x5	For gaps of 3 to 6 mm	White
'All Round' Seal 15x8	For gaps of 5 to 8 mm	White
'Dee' Seal	For gaps of 5 to 10 mm	Black
'Dee' Seal	For gaps of 5 to 12 mm	Black
'Dee' Seal	For gaps of 5 to 17 mm	Black

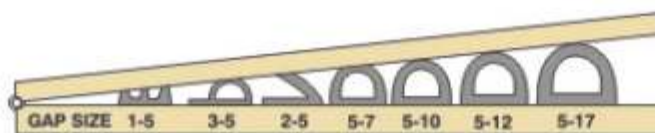
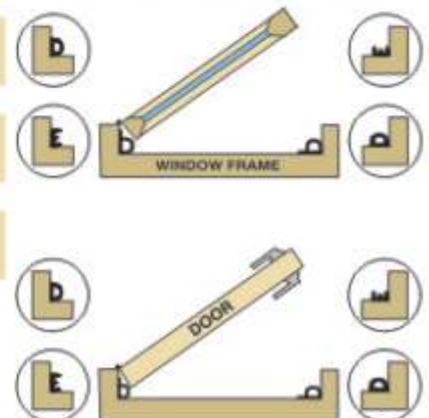

# SideO – Black Guard

Seal Code: *ES- BG*



For all kinds of Doors.



Black soft PVC profile inserted in slotted aluminium channel works as a guard to a number of problems that arise with doors. They are widely used in Industries, Hotels, Kindergarten Schools, Kitchens, etc.

## Installation Pattern :

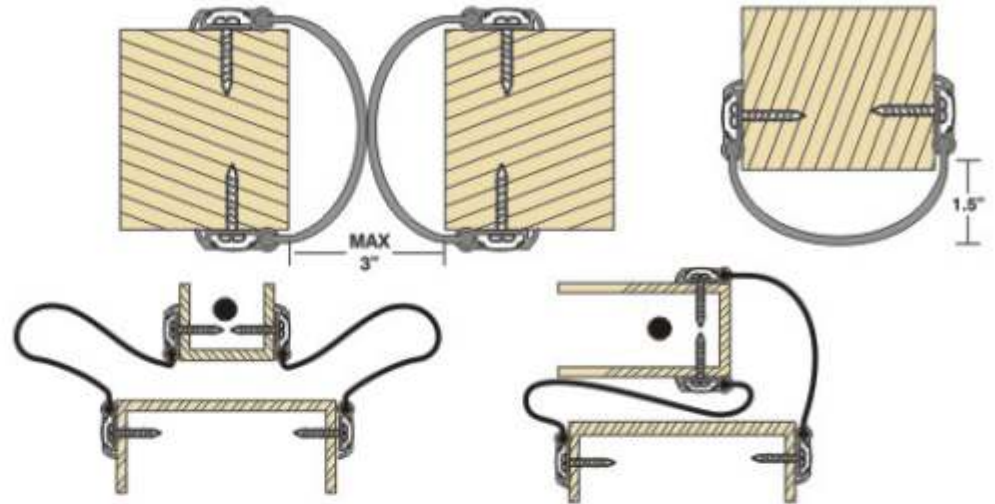
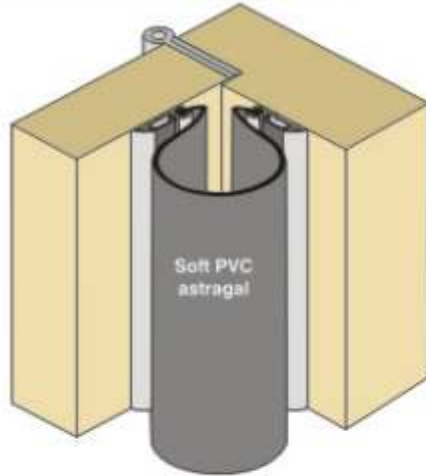

# Door Shoes

Seal Code: *ES- DS*

For Garage / Sliding Doors.

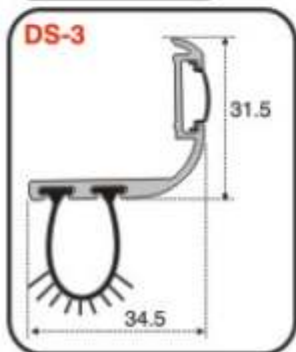

Available with soft Grey PVC Twin Legged **DS-1** profile, Pair of Black **DS-2** Profiles & Black Multi Fingered **DS-3** Profile.

Slotted holes are provided for easy adjustment / installation of this profile to the bottom or sides of the Wooden / Steel Garage Doors or Light / heavy sliding doors.



- Min/Max Gap** : 5mm - 20mm
- Lengths** : Till 12 feet
- Fixing** : Side Screwing to be done on the doors.
- Material** : Grey PVC insert or Black profiles.

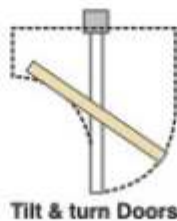

Tilt & turn Doors



Steel Shutter

**Door Shoe installed on Steel Rolling Shutters**

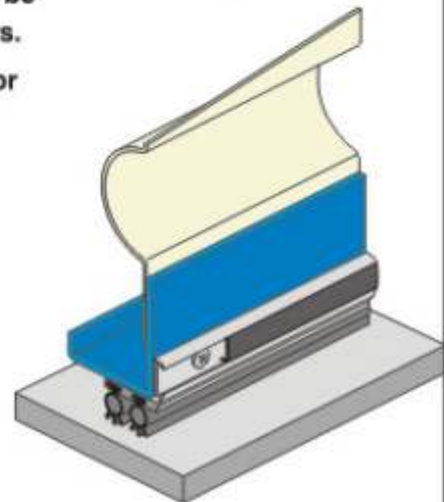

Tel.: (011) 2332 7868, 2371 7868

Fax : (011) 2373 1160



For all kinds of doors.



- Self Adhesive Polypropylene Seal for bonding to any clean and Dry surface. Unaffected by moisture and temperature.
- Allows sliding surface to move freely.
- Multi-purpose strip designed to fill gaps and stop rattles.
- Available in roll form of 5 meters to 300 meters.
- Colour black

## A Single leaf hinge door

- single side openable.
- Install on the three sides of frame.

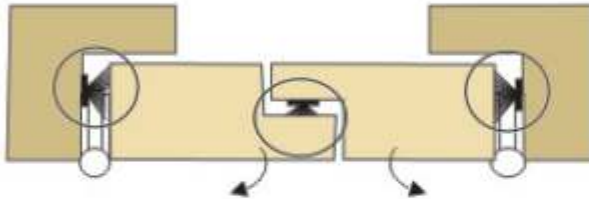

## B Double leaf hinge door

- Single side openable
- Install polypile on the three sides of frame & on the central meeting stile.

## C Floor Hinge Type

- Two way openable, double leaf door.
- Install polypile on the two sides of frame & on the central meeting stile of one door.

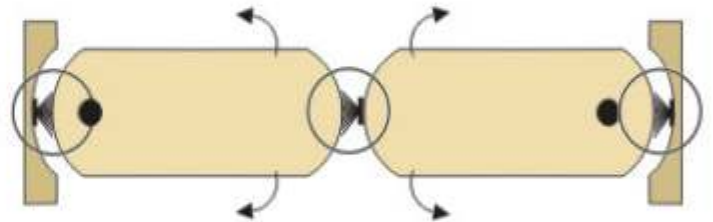

## D Sliding Door / Windows - even on the plain glass showroom windows

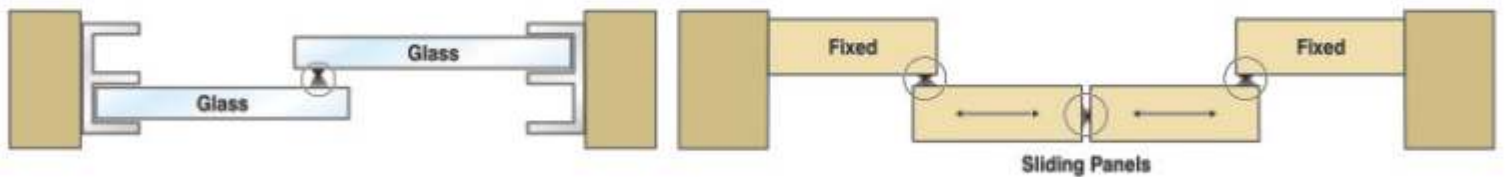

## E Sliding & Floding Door

- Install Polypile on one side of every door panel.

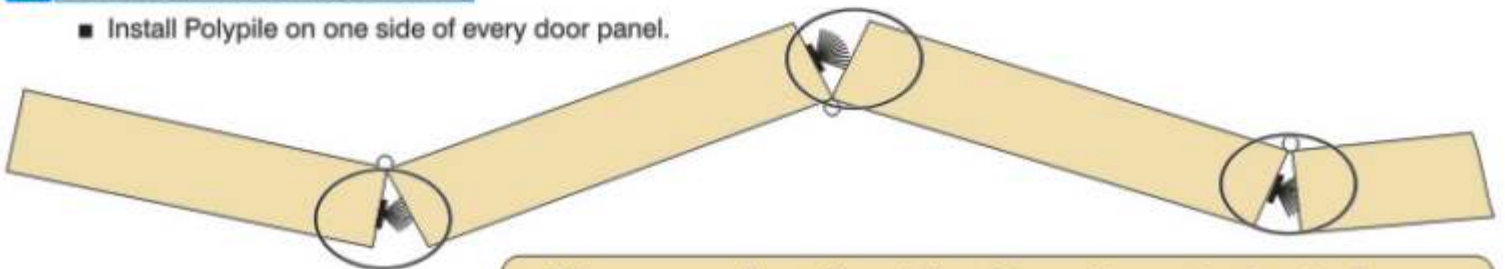

**They are also Good for Z section steel windows.**



# Dear Customers

At the time of Selecting, buying or recommending *Enviroseals* you must consider that :

- It should provide the required protection.
- It should not disturb the movement of the door.
- It should be compatible to the construction of the door and window & their other hardware.
- It should be suitable for the configuration of the door / window - like
  - A. **Butt hinged / Pivot Hung - single leaf - inward or outward opening door / window.**
  - B. **Butt hinged / Pivot Hung - Double leaf - inward or outward opening door / window.**
  - C. **Single / double leaf - both way opening door on floor hinge.**
  - D. **Meeting stiles - plain or rebated.**
  - E. **Wooden, Steel, Aluminum, PVC construction of door / window.**
  - F. **Sliding, Folding, Revolving or Floor Hinge door / window.**
  - G. **One Only active leaf ( in case of double leaf doors ).**
  - H. **Roll-up or Tilt - up garage doors.**
  - I. **Windows : casement, sash or Hopper.**

**Besides above - you must have proper knowledge of these terms :**

**Active doors :** (in a pair of doors) The leaf that opens first.

**Anodizing :** The anodizing process adds corrosion resistance and durability to the aluminium extrusions. The anodized finishes available include Clear and Bronze, conforming to building industry standards.

**Astragals :** Also know as "meeting Stile Seals", Astragal is a term used for the seal that seals the central joint of two swinging doors. A Profile or combination of seals applied to one or both doors of a pair at their meeting edges (meeting stiles.) The astragal closes the clearance gap for the purpose of either providing a weather seal, minimizing the passage of light between the doors.

**Broad Butt Hinge :** A wider version of the butt hinge.

**Center Pivot :** A special type of hanging device for heavy-duty doors that usually swing both ways (double acting.)

**Door Stop :** A device to limit the opening

swing of a door. Also, that part of a door frame against which the door closes.

**Double-Acting door :** A door equipped with hardware that permits it to swing to either side of the plane of the frame.

**E.P.D.M.:** (Ethylene Propylene Diene Monomer) rubber extrusions withstand the rigor of compression, heat, cold, water, ozone, UV light, abrasion and aging. EPDM rubbers have exceptional memory, which means that the sections will resume their original shape after long periods of compression, Service temperature - 40°C to 70°C.

**Escutcheon (Plate) :** An elongated plate, either protective or ornamental to the seals (like in the case of CATS ).

**Hinge Jamb :** Vertical member of a door frame to which the hinges are applied.

**Hinge Stile :** (of the door) The door stile to which the hinges are attached.

**Jamb :** The vertical members forming the side of a door, window or wall opening frame. The hinge jamb is the jamb to which the hinges and pivots are installed. The strike jamb is the jamb in which a strike may be installed and away from which the door or window swings. A **blank jamb** is one that has not been prepared to receive hardware.

**Latch bolt :** A lock component having a beveled end that projects from the lock front, but may be forced back into the lock case by send pressure or drawn back by action of the lock mechanism. When the door is closed, the latch bolt projects into a hole provided in the strike, holding the door in a closed position.

**Leaf (of a pair of doors) :** One of the two doors forming a pair or a double door.

**Lock Stile :** The Vertical member of the door to which the locking mechanism is applied.

**Meeting Stile :** The vertical edge of a door or window, in a pair, which is adjacent to the other door or window.

**Mill finish :** Mill finish is the raw finish (not anodized) of the aluminium, as it has been manufactured from the mill.

**Mortice :** An opening, recess or cutout made to receive a lock or other hardware. Also that act of making such an opening - like in the case of Drop Seals or at the time of installing TwinOO seal.

**Rebate :** A term used to define that portion of the door frame into which the door fits. Also a term used to describe the abutting edges of a pair of doors or windows so shaped as to provide a tight fit. One half of the edge projects beyond the other half, usually by 13mm.

**Sequence Closer :** A door closer that automatically closes a pair of fire rated doors in sequence, so as to ensure correct latching.

**Sill :** The stone or wood member across the bottom of the door or window opening. Also the bottom member on which the building frame rests (sill plate).

**Silicon :** These extruded seals withstand high temperatures and conform to BCA C3.4, "Smoke Doors 200" C for 30 minutes" Service temperature - 60°C to 230°C. S.E. (Self Extinguishing) where indicated.

**Situation :** Is it intended for external, internal, residential, commercial, fire door and so no?

**Stile :** The vertical member of a door to the lock and hinges are applied.

**Threshold Plate :** A strip fastened to the floor beneath a door. May be required to cover the joint of two types of floor materials where they meet.

**Weather Strip :** Narrow strips made of metal or other material, designed so that when installed at door or windows, it will retard the passage of air, moisture or dust around the door or window sash. moisture or dust around the door or window sash.

**At the time of Ordering - Please be sure of :-**

**Lengths :** Must be as per the sizes given in the tech blocks . Lengths over 12 feet - a pricing surcharge applies + delivery time increases.

**Specify :** Product name / Code number. Finish, Lengths size and quantity of goods.

**Ordering Abbreviations :-** CA : Clear Anodise BA : Bronze Anodise PC : Powder Coated

**Guarantee :** Enviroseals products are guaranteed for 2 year against defects in materials and workmanship, provided seals are fitted in accordance with manufacturer's specifications. NO claim for work done thereon or damage incurred will be allowed - only the exchange of defective goods will be done.

All technical data and recommendations, although based upon the research and believed to be reliable, are given in good faith but without warranty, It is understood that users will independently determine the suitability of products shown herein for their purposes shown herein for their purposes and as such - Enviroseals accepts no liability.

ENVIROSEALS reserves the right to alter, delete or make obsolete any product shown in this catalogue, without prior notice.

*log on to...*

**www.enviroseals.info**

At **E**nviroseals - **Dr. D&W** Pharmacy :  
We have more than 2,00,000 profiles to  
handle most of the known problems  
that arise with the **D**oors and the **W**indows.

Must for residential, commercial, industrial, institutional projects.....  
..... & also for Hospitals, Pharmaceutical Units, Houses, Hotels,  
Cinemas, Auditoriums, Studios, etc.

**www.enviroseals.info**

**Enviroseals** (A division of IFS)

513, New Delhi House

Barakhamba Raod, New Delhi - 110001

Tel. : (011) 2332 7868, 2371 7868 • Fax. : (011) 2373 1160

E-mail : [loto@vsnl.net](mailto:loto@vsnl.net), [esquare@vsnl.net](mailto:esquare@vsnl.net) • Website : [www.enviroseals.info](http://www.enviroseals.info)